



LA PASSIONE PRENDE FORMA

Esci dalla storia che ti trattiene. Entra nella storia che sei disposto a creare



COLLEZIONE 2025



AMBIENTAZIONI

COFFEE & PASTRY



AMBIENTAZIONI

BAKERY & PIZZA

Turn-Key Srl è dalla parte dei giovani e di chi si sente giovane, di chi ha voglia di cambiare, di trasformare in progetto il sogno che ha in testa. Di chi sa osare, gettarsi nella mischia e ballare, far rombare il motore. Crediamo che tutti abbiano diritto a un sogno. E se questo sogno è aprire un'attività, che sia un bar, una caffetteria, una pizzeria, una gastronomia, noi possiamo aiutarti a realizzarlo. Se finora questo sogno per te è rimasto qualcosa di irrealizzabile e il pensiero di tutte quelle spese da affrontare ti ha bloccato, **Turn-Key Srl**, con un prezzo leggero che, insieme alla nostra competenza, disponibilità, flessibilità, metterà le ali al tuo sogno senza costringerti a non sognare più qualcosa di diverso.

Turn-Key Srl è dalla parte di chi sa creare, con buon cibo, musica e un arredo adeguato, le giuste atmosfere capaci di far nascere incontri. Pensa a un locale giovane e accogliente, che sia una panetteria, un bar o caffetteria, una pizzeria o gastronomia. Pensa di poter essere tu la persona che lo crea, lo costruisce in base ai propri gusti e le proprie preferenze, che vi accoglie i clienti e ne raccoglie i commenti soddisfatti. La vita va veloce, muta, i sogni di oggi non sono quelli di domani. Oggi realizza con noi il sogno presente, lasciati trascinare dall'energia della nostra anima e continua a sognare. Con **Turn-Key Srl** puoi farlo senza pensieri.

Turn-Key Srl is on the side of young people and those who feel young, those who want to change, to transform the dream they have in their heads into a project. Those who know how to dare, throw themselves into the fray and dance, make the engines roar. We believe that everyone has the right to a dream. And if this dream is to open a business, be it a bar, a café, a pizzeria, a delicatessen, we can help you make it come true. If until now this dream has remained something unattainable for you and the thought of all those expenses to face have blocked you, **Turn-Key Srl**, with a light price which, together with our expertise, availability, flexibility, will give wings to your dream without forcing you to no longer dream of something different.

Turn-Key Srl is on the side of those who know how to create, with good food, music and appropriate furnishings, the right atmosphere capable of creating meetings. Think of a young and welcoming place, be it a bakery, a bar or cafe, a pizzeria or gastronomy. Think that you can be the person who creates it, builds it based on your own tastes and preferences, who welcomes customers and collects their satisfied comments. Life goes fast, changes, today's dreams are not those of tomorrow. Today realize the present dream with us, let yourself be carried away by the energy of our soul and continue to dream. With **Turn-Key Srl** you can do it without worries.

INDICE INDEX

- 02 TECNOLOGIA
- 06 IDEE DI CONCEPT
- 14 LINEA EASY
- 16 LINEA EASY + VERT
- 18 LINEA HYVE + BINGER
- 20 LINEA LUXOR + EASY
- 22 LINEA EASY (MARKET)
- 24 LINEA DOMINO + BASIC
- 26 LINEA WOOD + SUBWAY TILE
- 28 LINEA REGIORGIO
- 30 LINEA POP
- 32 LINEA VERT + HYVE
- 36 LINEA HYVE + FRAME
- 38 LINEA TUDOR
- 40 LINEA DOMINO
- 42 LINEA MIX
- 44 LINEA REGIORGIO
- 46 LINEA LUXOR + EASY
- 48 LINEA EASY + VERT
- 50 LINEA CROSS
- 52 LINEA REGIORGIO (MARKET)
- 54 LINEA CATHEDRAL
- 58 LINEA DONEY + LUXOR
- 60 LINEA BINGER
- 62 LINEA SUBWAY TILE
- 64 LINEA MIX
- 66 LINEA PROVENCE + EASY
- 68 LINEA RIVA
- 70 BANCHI ALIMENTARI PANORAMA
- 72 BANCHI ALIMENTARI START
- 74 SCAFFALATURA ALIMENTARE
- 80 SCEGLI IL TUO STILE
- 84 MATERIALI E FINITURE
- 88 DISEGNI TECNICI

VETRINA COMPACT
REFR. DISPLAY CASE COMPACT
TIPOLOGIA: FREDDO VENTILATO / TYPE: VENTILATED COLD



VETRINA SNACK
SNACK DISPLAY CASE
TIPOLOGIA: FREDDO STATICO, FREDDO VENTILATO, CALDO SECCO, BAIN-MARIE E NEUTRO / TYPE: STATIC COLD, VENTILATED COLD, HEATED DRY, BAIN-MARIE AND AMBIENT



BANCO DROP-IN
DROP-IN COUNTER
TIPOLOGIA: FREDDO VENTILATO, CALDO SECCO / TYPE: VENTILATED COLD, HEATED DRY



VETRINA GELATERIA E PASTICCERIA
GELATO AND PASTRY DISPLAY CASE
TIPOLOGIA: FREDDO VENTILATO / TYPE: VENTILATED COLD



CELLA REFRIGERATA
REFRIGERATED CELL
TIPOLOGIA: FREDDO STATICO / TYPE: STATIC COLD



BANCO ALIMENTARI PANORAMA
DELI COUNTER

TIPOLOGIA: FREDDO VENTILATO, CALDO VENTILATO E BAGNOMARIA / TYPE: VENTILATED COLD, VENTILATED HOT AND BAIN-MARIE



BANCO ALIMENTARI CON CELLA START
DELI COUNTER WITH REFR. STORAGE

TIPOLOGIA: FREDDO STATICO, FREDDO VENTILATO, CALDO SECCO E BAGNOMARIA / TYPE: STATIC COLD, VENTILATED COLD, HEATED DRY AND BAIN-MARIE



MURALE REFRIGERATO LATTICINI
REFRIGERATED DISPLAY CABINET

TIPOLOGIA: FREDDO VENTILATO / TYPE: VENTILATED COLD



PENSILE REFRIGERATO
REFRIGERATED WALL UNIT

TIPOLOGIA: FREDDO VENTILATO / TYPE: VENTILATED COLD



VASCA DROP-IN DA INCASSO REFR. STATICA
BUILT-IN STATIC-REFRIGERATED DROP-IN WELL

TIPOLOGIA: FREDDO STATICO / TYPE: STATIC COLD



VASCA DROP-IN DA INCASSO REFR. VENTILATA
BUILT-IN FAN-REFRIGERATED DROP-IN WELL

TIPOLOGIA: FREDDO VENTILATO / TYPE: VENTILATED COLD



PIANO DA INCASSO CALDO SECCO
BUILT-IN HEATED DRY PLATE

TIPOLOGIA: CALDO SECCO / TYPE: HEATED DRY



VASCA DROP-IN DA INCASSO BAGNOMARIA
BUILT-IN BAIN-MARIE DROP-IN WELL

TIPOLOGIA: AD ACQUA / AD ARIA / TYPE: HEATED WATER / HEATED AIR



ALCUNI CONCEPT DI ARREDAMENTO IDEATI CON LE NOSTRE ESTETICHE

SOME INTERIOR CONCEPTS DESIGNED WITH OUR PRODUCTS

PIZZERIA - LINEA **SUBWAY TILE + DOMINO**



BRITISH PUB - LINEA **TUDOR**



ALCUNI CONCEPT DI ARREDAMENTO IDEATI CON LE NOSTRE ESTETICHE

SOME INTERIOR CONCEPTS DESIGNED WITH OUR PRODUCTS

CAFFETTERIA - LINEA WOOD



BAR - LINEA EASY



ALCUNI CONCEPT DI ARREDAMENTO IDEATI CON LE NOSTRE ESTETICHE

SOME INTERIOR CONCEPTS DESIGNED WITH OUR PRODUCTS

PANETTERIA - LINEA LUXOR + PROVENCE



CAFFETTERIA - LINEA GINGER



ALCUNI CONCEPT DI ARREDAMENTO IDEATI CON LE NOSTRE ESTETICHE

SOME INTERIOR CONCEPTS DESIGNED WITH OUR PRODUCTS

BAR - LINEA VERT + EASY



BAR - LINEA RIVA



COSTO COMPOSIZIONE: € 12.999
CON FRONTALI BASK: € 12.899

LINEA EASY

NELL'IMMAGINE A SINISTRA:
FRONTALI BANCHI:
NOBILITATO EPHEUSUS + QUERCIA
PIANO LAVORO E BANCALINA:
HPL FINITURA EPHEUSUS.
ZOCCOLO: METALLO MICACEO
CON ILLUMINAZIONE A LED.

ON THE LEFT IMAGE:
FRONT CLADDINGS:
ENNOBLED WOOD EPHEUSUS + QUERCIA.
WORKTOP AND BAR COUNTERTOP:
HPL IN EPHEUSUS FINISHING.
PLINTH:
MICACEOUS METAL WITH
INTEGRATED LED LIGHTING.

NELL'IMMAGINE SOTTO:
FRONTALI BANCHI:
NOBILITATO CALACATTA + QUERCIA.
PIANO LAVORO E BANCALINA:
HPL FINITURA CALACATTA.
ZOCCOLO: METALLO MICACEO
CON ILLUMINAZIONE A LED.

ON THE IMAGE BELOW:
FRONT CLADDINGS:
ENNOBLED WOOD CALACATTA + QUERCIA.
WORKTOP AND BAR COUNTERTOP:
HPL IN CALACATTA FINISHING.
PLINTH:
MICACEOUS METAL WITH
INTEGRATED LED LIGHTING.





NELL'IMMAGINE A SINISTRA:
SCAFFALATURA ALIMENTARE:
SCHIENALI E PIANI
IN METALLO MICACEO.
VETRINA REFRIGERATA
VERTICALE:
CORPO ESTERNO NERO,
PANNELLO FRONTALE QUERCIA.

ON THE LEFT IMAGE:
SHELVING UNITS FOR
MARKETS:
RISER UNIT AND SHELVES IN
MICACEOUS METAL.
REFRIGERATED DISPLAY
CABINET:
BLACK PAINTED SIDE PANELS,
ANTIQUE OAK FRONT CLADDING.

NELL'IMMAGINE A DESTRA:
FRONTALI BANCHE: NOBILITATO
EPHESUS + EFFETTO DOGGIO
NOBILITATO QUERCIA.
PIANO LAVORO: HPL, EPHESUS.
ZOCCOLO: METALLO MICACEO.
BANCO ALIMENTARE:
MODELLO "START".
GONDOLE: SCHIENALI QUERCIA
E PIANI IN METALLO MICACEO.
MURALI: METALLO MICACEO.

ON THE RIGHT IMAGE:
FRONT CLADDINGS:
ENNOBLED WOOD
EPHESUS + SLATTED EFFECT IN
QUERCIA FINISHING.
WORKTOP: HPL, EPHESUS.
PLINTH: MICACEOUS METAL.
DELI COUNTER:
"START" MODEL.
GONDOLA RACKS: WOODEN
BACK IN QUERCIA FINISHING AND
MICACEOUS METAL LEDGES.
WALL RACKS:
MICACEOUS METAL.

COSTO COMPOSIZIONE: € 39.570
CON FRONTALI BASIC: € 37.170

LINEA
EASY + VERT





COSTO COMPOSIZIONE: € 43.999
CON FRONTALI BASIC: € 39.389

LINEA HYVE + GINGER

NELL'IMMAGINE A SINISTRA:
FRONTALI BANCHI:
TORTORA + GRAFITE.
PIANO LAVORO:
HPL EPHEBUS.
SCHIENALI: NOBILITATO EPHEBUS + TORTORA.
PANI SCAFFALATURA: QUERCIA.
ZOCOLO: METALLO MICACEO.

ON THE LEFT IMAGE:
FRONT CLADINGS:
TORTORA + GRAPHITE.
WORKTOP:
HPL EPHEBUS.
RISER UNITS: ENVELOPED WOOD EPHEBUS + DONE-GRAY.
SHELVING UNITS: ANTIQUE OAK.
PLINTH: MICACEOUS METAL.

NEL DETTAGLIO SOTTO:
BANCO A PROFONDITÀ SPECIALE CON TOP A SERRAJO.
SCAFFALE ESPOSITORE A 2 PIANI QUERCIA.

IN THE DETAIL BELOW:
AMBIENT COUNTER WITH CANTILEVER COUNTERTOP
AND DESPOKE DEPTH.
SHELVING UNIT WITH TWO LEDGES IN ANTIQUE OAK FINISHING.





FRONTALI BANCHE:
EFFETTO CANNETTINO
+ QUERCIA.
PIANO LAVORO + MISCITA:
HPL EPHESUS.
BANCALINA:
METALLO MICACEO.
ZOCOLLO:
METALLO MICACEO CON
ILLUMINAZIONE LED.
FRONT CLADDINGS:
RIBBED EFFECT
+ ANTIQUE OAK.
WORKTOP & SERVICE PLAN:
EPHESUS HPL.
UPPER TOP STRUCTURE:
MICACEOUS METAL.
PLINTH:
MICACEOUS METAL
WITH LED LIGHTING.

COSTO COMPOSIZIONE: € 27.920
CON FRONTALI BASIC: € 19.890

LINEA
LUXOR + EASY



NELL'IMMAGINE SOTTO:
SCAFFALE A TERRA "GREY TOWER" GRAFFITE
CON PORTA BOTTIGLIE IN METALLO MICACEO.
MURALE ENOTECA CON SCHEFFALE RAMATO E
PANI INCLINATI ROVERE.

ON THE IMAGE BELOW:
SELF-STANDING SHELVING UNIT "GREY TOWER"
IN GRAFFITE FINISHING,
WITH BOTTLE OPENSER MICACEOUS METAL.
WINERY RACKS WITH WOODEN BACK IN
RAMATO FINISHING AND INCLINED WOODEN
LEDGES IN ROVERE FINISHING.

ENOTECA



LINEA EASY

NELL'IMMAGINE A DESTRA:
FRONTALI BANCHE: NOBILITATO RAMATO.
PIANO LAVORO: LAMINATO ARDESIA.
ZOOCCOLO: METALLO MICACEO.
BANCO SALUMI: MODELLO "TRANDAM".

ON THE RIGHT IMAGE:
FRONT CLADINGS: ENNOBLED WOOD RAMATO.
WORKTOP: LAMINATE ARDESIA.
PLINTE: MICACEOUS METAL.
DELI COUNTER: "TRANDAM" MODEL.

COSTO COMPOSIZIONE: € 39.499
CON FRONTALI BASIC: € 38.999





COSTO COMPOSIZIONE: € 48.999
CON FRONTALI BASIC: € 42349

NELL'IMMAGINE A SINISTRA
FRONTALI BANCHI:
MOBILITATO QUERCIA + GRAFFITE.
PIANO MESCITA:
LAMINATO ARDESIA.
BANCALINA: METALLO MICACEO.
ZOCCHINO: METALLO MICACEO.

ON THE LEFT IMAGE
FRONT CLADDINGS:
ENNOBLED WOOD QUERCIA +
GRAFFITE.
SERVING PLAN:
LAMINATE ARDESIA.
BAR COUNTERTOP:
MICACEOUS METAL.
PLINTH: MICACEOUS METAL.

NELL'IMMAGINE A DESTRA
FRONTALI BANCHI: FINITURA
ROVERE + BRANCO LUCIDO.
PIANO MESCITA: BOTTICINO.
BANCALINA: METALLO BIANCO.

ON THE RIGHT IMAGE
FRONT CLADDINGS:
QUERCIA + GLOSSY WHITE
FINISH.
SERVING PLAN: BOTTICINO.
BAR COUNTERTOP:
WHITE METAL.



LINEA
DOMINO + BASIC



NEL IMMAGINE A SINISTRA:
FRONTALI BANCHI:
VERO LARICE ANTICO
+ MDF LACCATO GRIGIO.

ON THE LEFT IMAGE
FRONT CLADDINGS:
REAL ANTIQUE LARCH +
MATTE LACQUERED MDF
IN GRAPHITE FINISHING.

NELL'IMMAGINE A DESTRA:
FRONTALI BANCHI:
INOSBITATO QUERCIA +
MDF LACCATO GRAPTE.
PIANO LAVORO: ARDESIA.
ZOCCOLO: METALLO MICACEO.

ON THE RIGHT IMAGE:
FRONT CLADDINGS:
BINOBLED WOOD QUERCIA +
MATTE LACQUERED MDF
IN GRAPHITE FINISHING.
WORKTOPS: ARDESIA.
PLINTH: MICACEOUS METAL.

COSTO COMPOSIZIONE: € 18.772
CON FRONTALI BASIC: € 14.982

LINEA
WOOD + SUBWAY TILE



LINEA
WOOD ECO



LINEA
REGIORGIO

FRONTALI BANCHI:
GRAFITE CON DOGHE ROVERE.
PIANO LAVORO: ARDESIA.
ZOCCOLO: METALLO MICACEO.

FRONT CLADDINGS:
GRAPHITE WITH SLATS IN
ROVERE FINISHING.
WORKTOPS: ARDESIA.
PLINTH: MICACEOUS METAL.

COSTO COMPOSIZIONE: € 17,98
CON FRONTALI BASIC: € 14,888

COSTO COMPOSIZIONE: € 31.315
CON FRONTALI BASIC: € 29.585

LINEA
POP

NELL'IMMAGINE A DESTRA:
FRONTALI BANCHE:
MOBILIATO VERDE SALVA
CON INSERTI IN HPL BIANCO.
PIANO LAVORO
E PIANO MISCITA:
HPL BIANCO.
BANCALINA:
HPL FINITURA EPHEBUS.
ZOCOLLO:
METALLO VERNICIATO BIANCO.

ON THE RIGHT IMAGE:
FRONT CLADDINGS:
ENNOBLED WOOD SAGE GREEN
WITH DECOR IN WHITE HPL.
WORKTOP AND
BAR COUNTERTOP:
WHITE HPL.
BAR COUNTERTOP:
WHITE HPL.
PLINTH:
WHITE LACQUERED METAL.

NELL'IMMAGINE A SINISTRA:
FRONTALE:
MOBILIATO TORTORA +
HPL FINITURA EPHEBUS.
PIANO LAVORO:
HPL FINITURA EPHEBUS.

ON THE LEFT IMAGE:
FRONT CLADDINGS:
ENNOBLED WOOD
IN DOVE GREY
FINISHING + EPHEBUS HPL.
WORKTOP:
EPHEBUS HPL.





LINEA VERT + HYVE

COSTO COMPOSIZIONE: € 28.800
CON FRONTALI BASIC: € 23.999

NELL'IMMAGINE A SINISTRA:
FRONTALI BANCHE:
EFFETTO OGAIATO + VERDE.
PIANO LAVORO:
HPL CALACATTA.
ZOCOLO: METALLO MICACEO.

ON THE LEFT IMAGE:
FRONT CLADDINGS:
SLATTED EFFECT + GREEN.
WORKTOP: CALACATTA HPL.
PLINTH: MICACEOUS METAL.

NELL'IMMAGINE A DESTRA:
TOP ARDESIA ATTREZZATO
PER TEGOLE PIZZA CON RIALZI
METALLICI E PROFILI BATTITEGUE.

ON THE RIGHT IMAGE:
ARDESIA WORKTOP
EQUIPPED FOR PIZZA PAN WITH
METAL STOPPER.



COSTO COMPOSIZIONE RETRO: € 8.105

RETRO BANCO

BASI NEUTRO:
ANTE: ROVERE.
STRUTTURA: GRAFITE.
PIANO LAVORO: HPL CALACATTA.
BOTTIGLIERE: MODELLO HYVE.

ESPOSIZIONE PANE:
SCAFFALE A 3 RIPANI CON MONTANTI IN METALLO
MICACED E PIANI ROVERE.
PIANO INCLINATO DIGATO CON
FRONTALINO IN VETRO.
CELIPO CON ILLUMINAZIONE LED.

AMBIENT BACK BASE:
DOORS: OAK.
STRUCTURE: GRAPHITE.
WORKTOP: CALACATTA HPL.
WALL SHELF: HYVE MODEL.

BAKERY DISPLAY:
FLOORING SHELF WITH MICACEDUS UPRIGHTS AND
OAK SHELVES.
SLANTED INCLINED PLANE WITH GLASS FRONT.
RISER CEILING WITH LED LIGHTING.





LINEA HYVE + FRAME

FRONTALI:
NOBILITATO ROVERE +
NOBILITATO VERDE SALVIA.
TOP: LAMINATO ARDESIA.
ZOCOLLO: METALLO MICACCEO.
FINITURA RETROBANCO:
NOBILITATO ROVERE.
SCHENALI:
NOBILITATO GRAFITE.

FRONT CLADDINGS:
ENNOBLED WOOD ROVERE +
SAGE GREEN.
WORKTOP: LAMINATE ARDESIA.
PLINTH: MICACEDUS METAL.
BACK-COUNTERS FINISHING:
ENNOBLED WOOD ROVERE.
BACK RISERS:
ENNOBLED WOOD GRAFITE.



COSTO COMPOSIZIONE: € 41.586
CON FRONTALI BASIC: € 29.486

NELL'IMMAGINE A SINISTRA:
FRONTALI BANCHE: FINITURA
SBIANCATO.
ZOCOLLO: METALLO MICACEO.

ON THE LEFT IMAGE:
FRONT CLADDINGS:
BLEACHED OAK FINISH.
PLINTH: MICACEOUS METAL.

NELL'IMMAGINE A DESTRA:
FRONTALI BANCHE: FINITURA
LACCATO TORTORA CON CORNICI
IN FRASSINO VERNICIATO
BIANCO.
BANCALINA: METALLO BIANCO.
PIANO MESCTA: FENIX BIANCO.
ZOCOLLO: METALLO MICACEO.

ON THE RIGHT IMAGE:
FRONT CLADDINGS:
ENNOBLED WOOD IN DOVE-GREY
FINISHING WITH FRAMES IN
WHITE PAINTED ASH.
UPPER TOP STRUCTURE:
WHITE METAL.
SERVING PLAN: FENIX WHITE.
PLINTH: MICACEOUS METAL.



LINEA
TUDOR



COSTO COMPOSIZIONE: € 11.079
CON FRONTALI BASIC: € 13.988

LINEA DOMINO

NELL'IMMAGINE A SINISTRA:
FRONTALI:
INCRISTATO ROVERE SU SFONDO BIANCO OPACO.
TOP: LAMINATO ROVERE MACCHIATO.
ZOCCHIO: METALLO MICACEO.

ON THE LEFT IMAGE:
FRONT CLADDINGS:
ENCRUSTED WOOD ROVERE ON MATTE WHITE.
BACKGROUND WORKTOP:
LAMINATE ROVERE MACCHIATO.
PLINTH: MICACEOUS METAL.

NELL'IMMAGINE A DESTRA:
BANCO POZZETTO PANE CON DOGGHE IN LEGNO
E TECA IN VETRO SALDATA.
FINITURA RETROBANCO:
INCRISTATO ROVERE + INCRISTATO SBIANCATO.

ON THE RIGHT IMAGE:
AMBIENT COUNTER WITH BREAD BASIN, WITH
WOODEN SLATS AND WELDED FRAME GLASS.
BACK-COUNTERS FINISHINGS:
ENCRUSTED WOOD ROVERE + ENCRUSTED
WOOD SBIANCATO.



NELL'IMMAGINE SOTTO:
PANOTECA MODULARE CON ILLUMINAZIONE A LED.
COMPOSTA DA:
BASI CON ANTINE E CINTASE IN MOBILITATO VERDE SALVA, CREMAGLIERA CON SCHENALI
GRAFITE E CESTI PANE VERNICATI BIANCHI.

ON THE IMAGE BELOW:
MODULAR BREAD DISPLAY WITH LED LIGHTING.
CONSISTING OF:
STORAGE CABINETS WITH SAND GREEN ENAMELED WOOD SHUTTERS AND DECORS,
GRAPHITE RACKS AND WHITE METAL BREAD BASKETS.

PANOTECA

Nos pains et baguettes



NELL'IMMAGINE A DESTRA:
FRONTALI BANCHE:
ROVERE + CALACATTA.
PIANI LAVORO:
ROVERE MACCHIATO.
ZOCCOLO:
METALLO MICACEO.

ON THE RIGHT IMAGE:
FRONT CLADDINGS:
ENAMELED WOOD ROVERE + CALACATTA.
WORKTOP:
LAMINATE ROVERE MACCHIATO.
PLINTE:
MICACEOUS METAL.

COSTO COMPOSIZIONE: € 46.203
CON FRONTALI BASIC: € 43.123





COSTO COMPOSIZIONE: € 42.740
CON FRONTALI BASIC: € 42.020

NELL'IMMAGINE A SINISTRA:
FRONTALI BANCHE:
BIANCO OPACO CON DOGHE
IN ROVERE.
PIANO LAVORO E PIANO
MESCITA:
ROVERE MACCHIATO,
BANCALINA E ZOCCHOLI:
METALLO BIANCO.

ON THE LEFT IMAGE:
FRONT CLADDINGS:
MATT WHITE WITH
STIVES IN OAK.
WORKTOP & SERVING PLAN:
MACCHIATO OAK.
UPPER TOP STRUCTURE &
PLINTH: WHITE METAL.



NELL'IMMAGINE SOPRA:
FRONTALI BANCHE:
GRAPITE CON DOGHE IN ROVERE.
PIANO LAVORO E PIANO MESCITA:
BOTTONI.
BANCALINA E ZOCCHOLI:
METALLO MICACEO.

ON THE IMAGE ABOVE:
FRONT CLADDINGS:
GRAPHITE WITH STIVES IN OAK.
WORKTOP & SERVING PLAN:
BOTTONI.
UPPER TOP STRUCTURE & PLINTH:
MICACEOUS METAL.

LINEA
REGIORGIO

COSTO COMPOSIZIONE: € 50.962
(NON DISPONIBILE CON FRONTALE CURVO LINEA BASIC)

LINEA LUXOR + EASY



NELL'IMMAGINE A SINISTRA:
FRONTALI BIANCHI
EFFETTO CANNETTINO
+ RAMATO
PIANO LAVORO:
FENIX BIANCO
ZOCCHIO:
METALLO INCASSO.

ON THE LEFT IMAGE:
FRONT CLADDINGS:
RIBBED EFFECT
+ COPPERY
WORKTOP:
WHITE FENIX
PLINTH:
MICAEOUS METAL

NELL'IMMAGINE A DESTRA:
FRONTALI BIANCHI
EFFETTO CANNETTINO
+ CALACATA
PIANO LAVORO:
FENIX BIANCO
ZOCCHIO:
OTONE.

ON THE RIGHT IMAGE:
FRONT CLADDINGS:
RIBBED EFFECT
+ CALACATA
WORKTOP:
WHITE FENIX
PLINTH:
BRASS





COSTO COMPOSIZIONE: € 54.000
CON FRONTALI BASIC: € 50.050

NELL'IMMAGINE A SINISTRA:
FRONTALI BANCHE:
EFFETTO OGGIATO FINITURA OP
SATINATO + CALACATTA.
PIANO MESCITA:
FENIX EGGIO.
BANCALINA: OTTONE.
ZOCCOLO: OTTONE.

ON THE LEFT IMAGE:
FRONT CLADDINGS:
SLATTED EFFECT IN SATIN GOLD
FINISHING + CALACATTA.
SERVING TOP: GREY FENIX.
BAR COUNTERTOP: BRASS.
PLINTE: BRASS.

LINEA
EASY + VERT

COSTO COMPOSIZIONE: € 43.934
CON FRONTALI BASIC: € 43.924

LINEA CROSS



NELL'IMMAGINE A SINISTRA:
FRONTALI BIANCHI
FONDO CALACATTA + FASCIA
SUPERIORE CON LISTELLI IN
OTTONE SATINATO.
PIANO LAVORO: HPL NERO.
ZOCCHOLI: MICACEO CON
ILLUMINAZIONE LED.

ON THE LEFT IMAGE:
FRONT CLADDING:
CALACATTA + UPPER BAND WITH
STRIPS IN SATIN BRASS.
WORKTOP: BLACK HPL.
PLINTH: MICACEOUS METAL WITH
LED LIGHTING.

NELL'IMMAGINE A DESTRA:
FRONTALI BIANCHI
FONDO CALACATTA + FASCIA
SUPERIORE CON LISTELLI IN
OTTONE SATINATO.
PIANO LAVORO: HPL NERO.
ZOCCHOLI: METALLO MICACEO
CON ILLUMINAZIONE LED.

ON THE RIGHT IMAGE:
FRONT CLADDING:
CALACATTA + UPPER BAND WITH
STRIPS IN SATIN BRASS.
WORKTOP: BLACK HPL.
PLINTH: MICACEOUS METAL
WITH LED LIGHTING.



COSTO COMPOSIZIONE: € 46.754
CON FRONTALI BASIC: € 43.314

NELL'IMMAGINE SOTTO:
BANCO MACELLERIA:
MODELLO "PANORAMA" NELLA VERSIONE
BANCO FINO CON DOGHE ROVERE.

ON THE IMAGE BELOW:
DELI COUNTER:
"PANORAMA" MODEL IN MATTE WHITE
BACKGROUND VERSION WITH ROVERE SLATS.

BANCO ALIMENTARI PANORAMA (vedi pag. 70/71)



NELL'IMMAGINE A DESTRA:
FRONTALI BANCHE:
GRAFITE CON DOGHE IN ROVERE.
PIANO LAVORO:
ROVERE MACCHIATO.
ZOCCOLO: METALLO MICACED.
BANCO MACELLERIA:
MODELLO "PANORAMA".
ALTRI ELEMENTI IN ARREDO:
ESPOSITORE PANE "TOTEM" SU
RUOTE; PENSILE REFRIGERATO.

ON THE RIGHT IMAGE:
FRONT CLADDINGS:
GRAFITE BACKGROUND
WITH ROVERE SLATS.
WORKTOP:
LAMINATE ROVERE MACCHIATO.
PLINTH: MICACEDUS METAL.
DELI COUNTER:
"PANORAMA" MODEL.
OTHER FURNISHING
COMPONENTS:
"TOTEM" BREAD DISPLAY
ON WHEELS; SUSPENDED
REFRIGERATED DISPLAY CASE.



LINEA REGIORGIO

COSTO COMPOSIZIONE: € 32.882
CON FRONTALI BASIC: € 33.227

LINEA CATHEDRAL

FRONTALI BANCHE:
GRANITE O SBIANCATO
CON DECORO IN ESSRANO
E CORNICI IN FRASSINO
VERNICIATO GRIGIO
O SBIANCATO.
**PIANO LAVORO E PIANO
MISCITA-BOTTIGLINO:**
BANCALINA-METALLO BIANCO
ZOCCHIO: METALLO MICACED
O PELLITO.

FRONT CLADDINGS:
GRAPHITE OR BLEACHED OAK
WITH DECORATION IN FOAM AND
FRAMES IN PRINTED GRAPHITE
OR BEACHED KASHWOOD.
WORKTOP & SERVICE PLAN:
BOTTICINO.
UPPER TOP STRUCTURE:
WHITE METAL.
PLINTH: MICACEDUS METAL
OR PEWTER.

COSTO COMPOSIZIONE: € 14.300
CON FRONTALI BASIC: € 12.540

LINEA CATHEDRAL

FRONTALI BANCHI:
SERIATO CON DECORO
IN ESPANNO E CORNICI
IN FRASSINO.
PIANO LAVORO: ARDESIA.
ZOCOLLO: METALLO MICACEO.

FRONT CLADDINGS:
BLEACHED OAK WITH
DECORATION IN FOAM AND
FRAMES IN ASHWOOD.
WORKTOP: ARDESIA.
PLINTH: MICACEOUS METAL.





LINEA
DONEY + LUXOR

COSTO COMPOSIZIONE: € 22.147
CON FRONTALI BASIC: € 20.607



NELL'IMMAGINE A SINISTRA:
FRONTALI:
NOBILTÀ SBIANCATO
+ MDF LACCATO OPACO.
PIANO MESICITA:
FENIX BIANCO.
BANCALINA: METALLO
VERNICATO BIANCO.
ZOCCOLO: METALLO MICACEO.

ON THE LEFT IMAGE:
FRONT CLADDINGS: ENNOBLED
WOOD SBIANCATO + WHITE
LACQUERED MDF.
SERVING TOP: WHITE FENIX.
BAR COUNTERTOP: WHITE
LACQUERED METAL.
PLINTE: MICACEOUS METAL.

NELL'IMMAGINE SOPRA:
TAVOLO MODELLO EKO
CON PIANA IN NOBILTÀ
SBIANCATO E SEDIE MODELLO
TOLIX IN METALLO PALLATO E
SPAZZOLATO.

ON THE IMAGE ABOVE:
TABLE MODEL EKO WITH
SBIANCATO ENNOBLED WOOD
SURFACE AND METAL CHAIRS
MODEL TOLIX.



COSTO COMPOSIZIONE: € 29.014
CON FRONTALI BASIC: € 26.284

NELL'IMMAGINE SOTTO:
BANCO MACELLERIA MODELLO "START"
NELLA VERSIONE LINEA WOOD CON VERO
LARICE ANTICO.

ON THE IMAGE BELOW:
DELI COUNTER "START" MODEL IN AESTHETIC
LINE WOOD, WITH REAL ANTIQUE LARCH.

BANCO ALIMENTARI
START (vedi pag. 73/75)



NELL'IMMAGINE A DESTRA:
FRONTALI BANCHE:
MDF BIANCO LUCIDO + GRAFFIO,
PIANO LAVORO:
ARDESIA.
ZOCCOLO: METALLO MICACED.
BANCHI GASTRONOMIA: MODELLO
"START".
ALTRI ELEMENTI IN ARREDO:
ESPOSITORI ORTOFRUTTA IN METALLO
MICACED (GONDOLE, MURALI E
BANCarelLE AUTO-PORTANTI).

ON THE RIGHT IMAGE:
FRONT CLADDINGS:
GLOSSY WHITE MDF
+ ENNOBLED WOOD GRAFFIO.
WORKTOP: LAMINATE ARDESIA.
PLINTH: MICACEDUS METAL.
DELI COUNTERS:
"START" MODEL.
OTHER FURNISHING COMPONENTS:
FRUIT&VEGETABLES RACKS IN
MICACEDUS METAL FINISHING
(GONDOLA, WALL RACKS AND
SELF-STANDING STALLS).



LINEA
SUBWAY TILE



COSTO COMPOSIZIONE: € 32.463
CON FRONTALI BASIC: € 35.153

NELL'IMMAGINE A SINISTRA
FRONTALI BANCHE: FINITURA
SERIATO + RAMATO.
PIANO MISCITA: FENIX BIANCO.
ZOCCOLO: METALLO MICACEO.

ON THE LEFT IMAGE
FRONT CLADDINGS:
BLEACHED + COPPERY FINISH.
SERVING PLAN: FENIX WHITE.
PLINTH: MICACEOUS METAL.

LINEA
MIX



NELL'IMMAGINE SOPRA:
HOT TELEFERA METALLICA.

ON THE LEFT IMAGE:
METALLIC BOTTLE RACK.



COSTO COMPOSIZIONE: € 12.014
CON FRONTALI BASIC: € 13.254

LINEA
**PROVENCE
+ EASY**

FRONTALI BANCHE:
MDF LACCATO BIANCO OPACO +
NOBILITATO ROVERE.
PIANO LAVORO:
ROVERE MACCHIATO.
ZOCOLLO: METALLO MICACED.

FRONTALI BANCHE:
MDF LACCATO BIANCO OPACO
+ NOBILITATO ROVERE.
WORKTOPS:
MACCHIATO DARK.
PLINTE: MICACEDUS METAL.





COSTO COMPOSIZIONE: € 29.850
CON FRONTALI BASIC: € 25.450

NEL L'IMMAGINE A SINISTRA:
FRONTALI BASIC:
OXIMÉ VERNICIATO BIANCO
OPACO CON INSEITI COLORE
VERDE ACQUA IN LAMINATO E
CORNICI IN FRASSINO
**PIANO LAVORO E PIANO
MISCITA:**
LAMINAM CALCE BIANCO
ZOCCOLO: METALLO
VERNICIATO RAL 9007
STRUTTURA INTERAMENTE IN
ACCIAIO INOX.

ON THE LEFT IMAGE:
FRONT CLADDINGS:
MATE WHITE LACQUERED
OXIMÉ WITH AQUA GREEN
LAMINATED INSERTS AND
ASHWOOD FRAMES.
WORKTOP:
WHITE LIME GRES (LAMINAM)
PLINTH: WHITE PAINTED METAL
(RAL 9007)
STAINLESS STEEL STRUCTURE.



NEL DETTAGLIO SOPRA:
LINEA RIVA IN VERSIONE
OXIMÉ IN FINITURA MOGANO.

ON THE IMAGE ABOVE:
RIVA AESTHETIC LINE IN
WOODEN MOHOGANY OXIMÉ FINISHING.

LINEA
RIVA

BANCHI ALIMENTARI PANORAMA

DESIGN MODERNO, MASSIMA VISIBILITÀ DEI PRODOTTI.
OGGIADI DI CASTELLO VETRI RIBALTABILI IN BASSO.
CELLA DI RISERVA NON INTEGRABILE.

MODERN DESIGN, MAXIMUM VISIBILITY OF THE PRODUCTS.
EQUIPPED WITH DOWNWARDS FOLDABLE GLASS.
REFRIGERATED STORAGE NOT AVAILABLE.

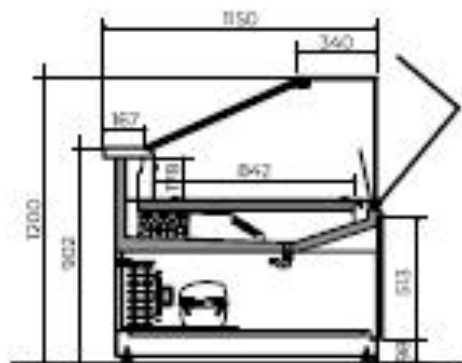

FREDDO VENTILATO _ COLD VENTILATED
Dim: 1500-2000-2500-3000 mm

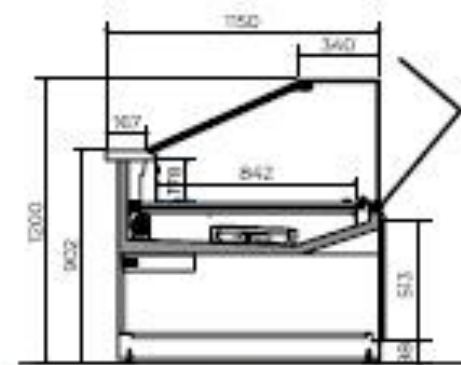

CALDO VENTILATO _ HOT VENTILATED
Dim: 1500-2000-2500-3000 mm

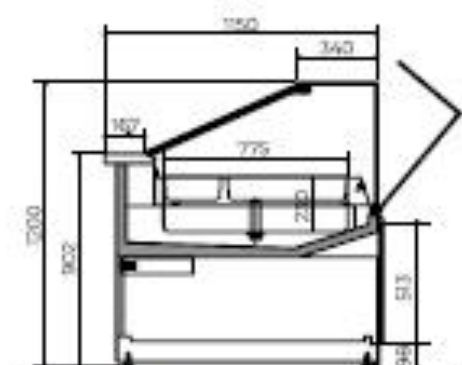

BAGNOMARIA _ DANUBIO
Dim: 1500 mm

IDEALE PER CARNI / SALUMI / GASTRONOMIA
IDEAL FOR MEATS / CURED MEATS / GASTRONOMY

PANORAMA REFRIGERATO VENTILATO _ VENTILATED COLD				
LENGTH	POWER CONSUMPTION	POWER SUPPLY	COOLING CAPACITY REQUIRED AT 0°C	OPERATING TEMPERATURE
1500 mm	1050W	230 V 50 Hz	100 W	+2°C / +5°C
2000 mm	1370W	230 V 50 Hz	1300 W	+2°C / +5°C
2500 mm	1690W	230 V 50 Hz	1600 W	+2°C / +5°C
3000 mm	2010W	230 V 50 Hz	2000 W	+2°C / +5°C

PANORAMA CALDO VENTILATO _ VENTILATED HOT				
LENGTH	POWER CONSUMPTION	POWER SUPPLY	OPERATING TEMPERATURE	
1500 mm	2000W	230 V 50 Hz	+40°C / +70°C	
1500 mm	3130W	230 V 50 Hz	+40°C / +70°C	

PANORAMA BAGNOMARIA _ DANUBIO				
LENGTH	POWER CONSUMPTION	POWER SUPPLY	OPERATING TEMPERATURE	
1500 mm	3650W	400 V 50 Hz	+60°C / +90°C	



PUNTI DI FORZA

- zero esposizione ventilata non
- vasca evapora-condensa integrata
- cristalli anteriori termoisolati ribaltabili in basso
- scomelli posteriori in policarbonato
- illuminazione LED a doppia fila
- quadro comandi digitale
- evaporatore a valvole
- verniciatura protettiva per evaporatore (optional)

PRODUCT PLUS

- black painted display area
- condensate container and evaporator included
- heat sealed front glass, downwards flip-open
- back sliding polycarbonate closure
- double row led lighting system
- digital control panel
- valve system evaporator
- protective coating for evaporator (optional)

BANCHI ALIMENTARI START

UNA VETRINA NATA PER SODDISFARE OGNI ESIGENZA.
VETRI FRONTALI APRIBILI VERSO L'ALTO.
DOTATA DI CELLA DI RISERVA.

A COUNTER BORN TO SATISFY EVERY NEED.
FRONT GLASSES THAT CAN BE OPENED UPWARDS.
EQUIPPED WITH REFRIGERATED STORAGE.

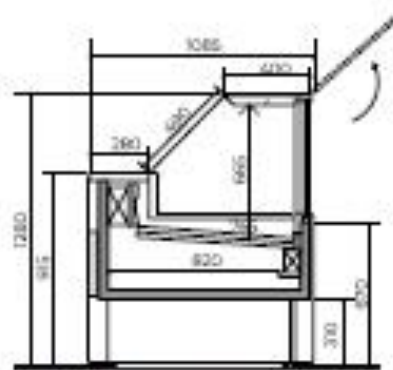

FREDDO STATICO CON CELLA
STATIC COLD WITH REFRIGERATED STORAGE
Dim: 1600-2000-2500-3000 mm

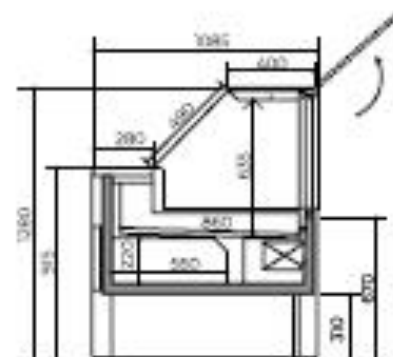

FREDDO VENTILATO CON CELLA
VENTILATED COLD WITH REFRIGERATED STORAGE
Dim: 1600-2000-2500-3000 mm

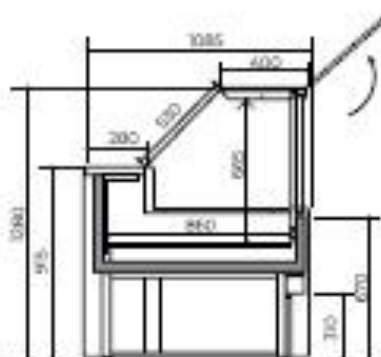

CALDO SECCO _ DRY HEATED
Dim: 1000-1500 mm

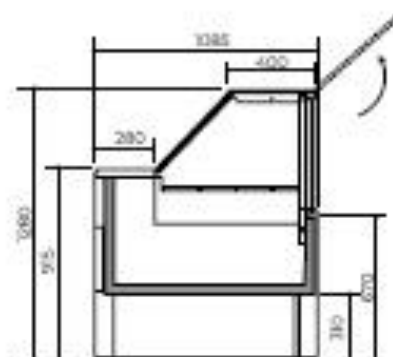

BAGNOMARIA _ BAIN MARIE
Dim: 1500 mm

IDEALE PER CARNI / SALUMI / GASTRONOMIA
IDEAL FOR MEATS / CURED MEATS / GASTRONOMY

START FREDDO STATICO CON CELLA _ STATIC COLD WITH REFR. STORAGE									
LENGTH	COMPRESSOR	LIGHTING	GAS QUANTITY	TYPE OF GAS	HP	REFRIGERATION POWER	WATT ABSORBED	FAB ABSORPTION (W)	TUBES WITHOUT UNIT
1600 mm	EMT0440K	1 x D w	0,065	R 290	1/4 HP	338	103	/	8 6
2000 mm	EMT0656K	2 x D w	0,10	R 290	1/3 HP	464	274	/	8 6
2500 mm	NEK0210K	2 x D w	0,15	R 290	1/2 HP	660	373	/	8 6
3000 mm	NEU0210K	2 x D w	0,20	R 290	1/2 + HP	715	550	/	8 6

START FREDDO VENTILATO CON CELLA _ VENTILATED COLD WITH REFR. STORAGE									
LENGTH	COMPRESSOR	LIGHTING	GAS QUANTITY	HP	REFRIGERATION POWER	WATT ABSORBED	FAB ABSORPTION (W)	TUBES WITHOUT UNIT	
1600 mm	NEK0210K	1 x D w	0,120	1/2 HP	705	401	19	8 6	
2000 mm	NEK0210K	2 x D w	0,120	1/2 + HP	947	750	38	8 6	
2500 mm	NEK0210K	2 x D w	0,120	3/4 + HP	1136	750	38	8 6	
3000 mm	NT02220K	2 x D w	0,120	1 - HP	1301	977	57	10 6	



LUNGHEZZA
length
1600-3000 mm



PROFONDITÀ
depth
600 mm



CLASSE CLIMATICA
climate class
SNP / 3°C - 12°C



PUNTI DI FORZA

- vetri apribili verso l'alto
- robusta struttura in alluminio
- illuminazione LED
- zona espositiva in acciaio inox
- piano di lavoro standard in acciaio inox
- evaporatore protetto con verniciatura

PRODUCT PLUS

- upwards opening glass
- sturdy steel frames
- LED lighting system
- stainless steel display area
- stainless steel workshop
- evaporator protected with coating

START CALDO SECCO _ DRY HEAT		
LENGTH	LIGHTING	WATT ABSORBED
1000 mm	1 x D w	400
1500 mm	1 x D w	500

START BAGNOMARIA _ BAIN MARIE		
LENGTH	LIGHTING	WATT ABSORBED
1500 mm	1 x D w	3400

BACINELLE GASTRONOMICHE INFERIBILI
FOR GASTRONOMIC BASINS

2 GN1/6 - 1 GN1/4 - 2 GN1/3 - 3 GN1/2 - 2 GN2/3

S= ASPIRAZIONE
D= MANOPOLA PER CALIFORNIA
I dati delle unità si riferiscono alla versione con
gruppo incorporato. Per la versione gruppo a distanza il calcolo
deve essere fatto dal frigorista.

ESPOSITORI PRODOTTI FOOD SCAFFALATURA ASOLATA

LA NUOVA SCAFFALATURA ASOLATA BY BKI ITALY. GRAZIE ALLA MODULARITÀ DELLE STRUTTURE E ALLA FACILITÀ DI ASSEMBLAGGIO, LO SCAFFALE PUÒ ESSERE CONFIGURATO IN ELEMENTI A PARETE, O CENTRALI, LINEARI O ANGOLARI. UN SISTEMA ESPOSITIVO SEMPLICE E FUNZIONALE PER IL RETAILER E PER IL CONSUMATORE ADATTO A QUALSIASI TIPOLOGIA DI AMBIENTE.

THE NEW SLOTTED RACKS BY BKI ITALY. THANKS TO THE MODULARITY OF THE STRUCTURES AND THE EASE OF ASSEMBLY, THE SHELF CAN BE CONFIGURED AGAINST THE WALL OR AS A CENTRAL ELEMENT, LINEAR OR ANGULAR. A SIMPLE AND FUNCTIONAL DISPLAY SYSTEM FOR THE RETAILER AND THE CONSUMER, SUITABLE FOR ANY TYPE OF ENVIRONMENT.

**PIANO SOSPESO
IN LAMIERA CON MENSOLE**
METAL SHELF
WITH LEDGES
Lunghezza: 650 - 1000 mm
Profondità: 400 mm
Portata: 170 kg

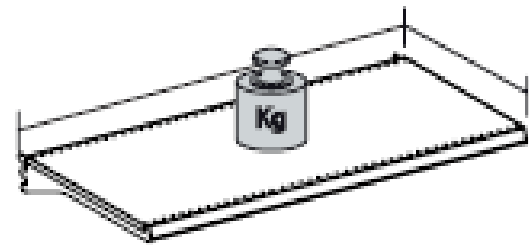

**PIANO BASE
IN LAMIERA**
METAL BASE
WITH LEDGES
Lunghezza: 650 - 1000 mm
Profondità: 400 mm
Portata: 230 kg

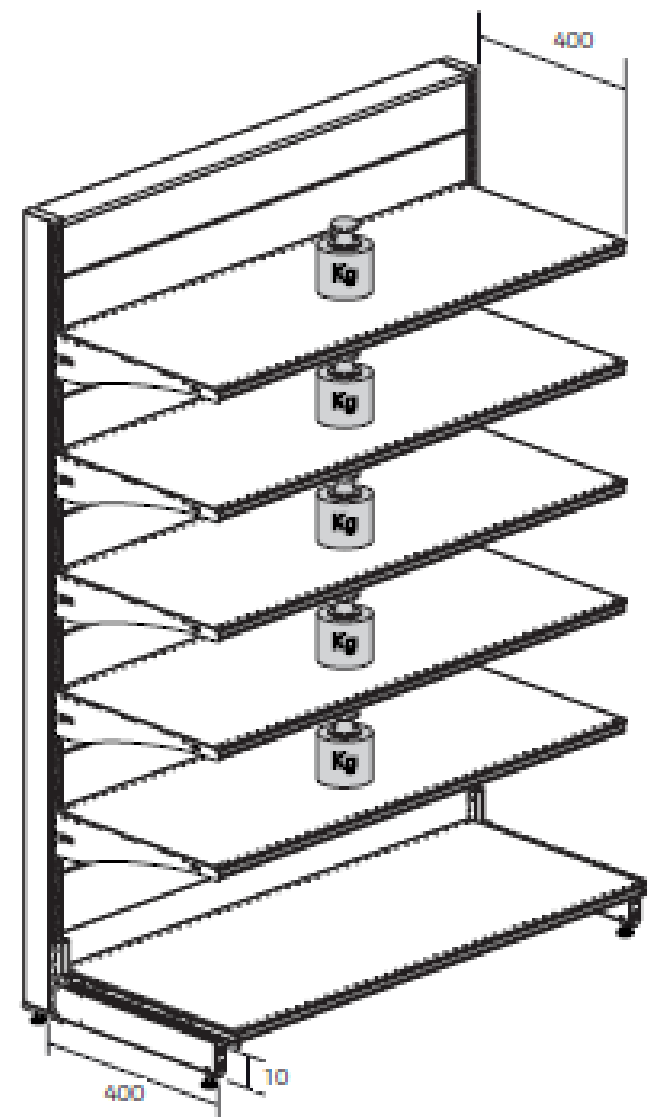
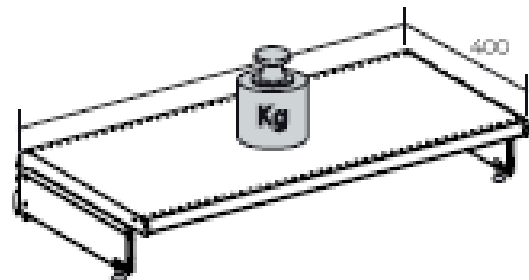

ELEMENTO MURALE H 2043 mm BASE 160 mm CON 5 PIANI SOSPESI (PIANO BASE ESCLUSO)
PORTATA: 225 Kg

WALL RACK H 2043 mm BASE H 160 mm WITH 5 SHELVES (EXCLUDED BASE)
MAXIMUM CHARGE: 225 Kg

MONTANTI
DIMENSIONE INGOMBERI
STRUT
SIZE AND OVERALL DIMENSIONS

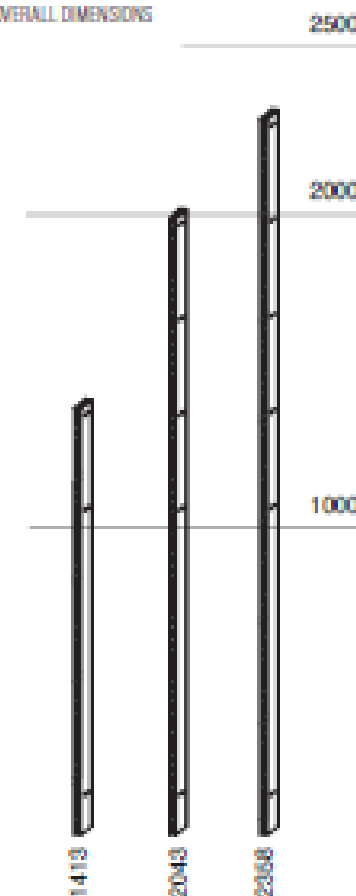

COMPOSIZIONI SCHIENALI PER MURALE/GONDIOLA
SCHIENALE LISCIO
RISER UNITS STRUCTURE FOR WALL DISPLAY/GONDIOLA
SMOOTH RISER UNIT

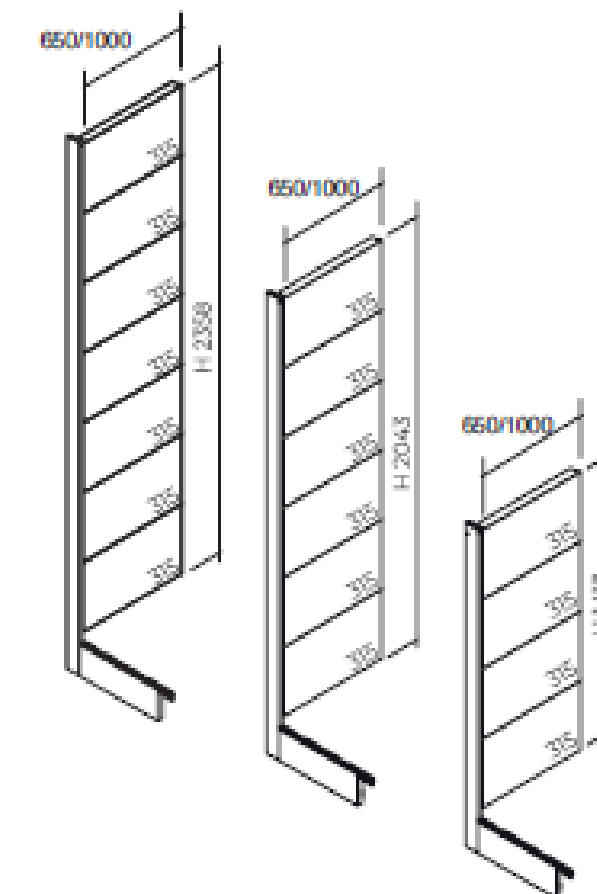

NON SOLO LO SCAFFALE A RIFIANI, MA ANCHE SISTEMI PER L'ESPOSIZIONE DEL VINO OPPURE DEGLI ALIMENTI ORTOFRUTTA.
NOT ONLY A SIMPLE SLOTTED RACK, BUT A COMPLETE DISPLAY SOLUTION, ALSO AVAILABLE FOR WINERIES AND F&V SHOPS.

ACCESSORIO PER ENOTECA
Sponda in filo H 75 mm
WINERY ACCESSORY
Wire front riser h 75 mm



ACCESSORIO PER ENOTECA
Divisore in filo H 75 mm
WINERY ACCESSORY
Wire partition for bottles h 75 mm

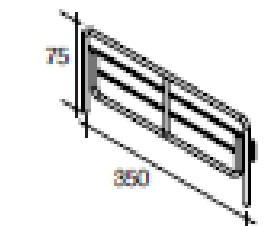

MONTANTI
DIMENSIONI E PASSO

Struttura solida e robusta, formata da montanti con scola a passo 35 mm.

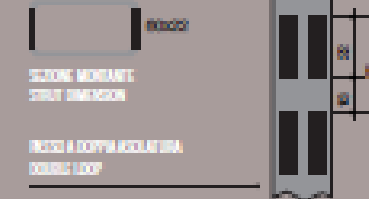

STRUT
OVERALL DIMENSION AND MODULE PITCH
Sturdy structure, slots of 35mm pitch.

COMPONENTI DI STRUTTURA
MENSOLE

Mensola inclinabile +10° / 0° / -10° / -20°. Per piani in lamiera in legno.

STRUCTURE COMPONENTS:
LEDGES
Tiltable ledge +10° / 0° / -10° / -20° for both metallic and wooden shelves.

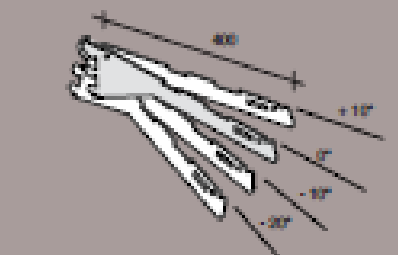

ESPOSITORI PRODOTTI FOOD MURALE

LA SCAFFALATURA SI DISTINGUE PER LE PERFORMANCE PRESTAZIONALI, PER LE FORME ARMONICHE E PER LA PRESENZA DI UNA LAMPIA GAMMA DI FINITURE. QUESTA È INDICATA PER ARRECCARE NEGOZI E SUPERMERCATI, CON UN OTTIMO RAPPORTO QUALITÀ-Prezzo.

THE SHELVING IS DISTINGUISHED BY ITS PERFORMANCE, ITS HARMONIOUS SHAPES AND A WIDE RANGE OF FINISHES. IT IS SUITABLE FOR FITTING OUT SHOPS AND MARKETS, WITH AN OPTIMAL PRICE-PERFORMANCE RATIO.



DIMENSIONI INGOMBRI
PASSO E MODULO

SIZES AND OVERALL DIMENSIONS
MODULE FITCH

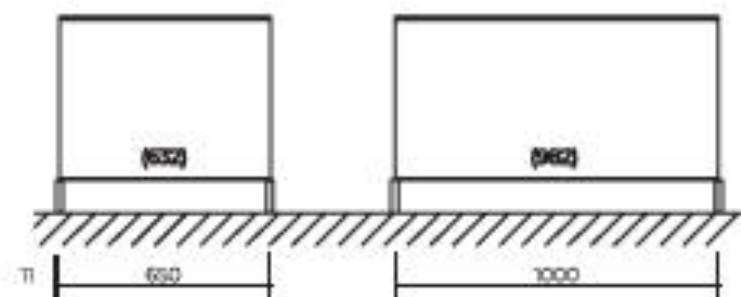

SEZIONE MURALE
WALL DISPLAY SECTION
Altezza: 2065 - 2390 mm
Profondità: 485 mm

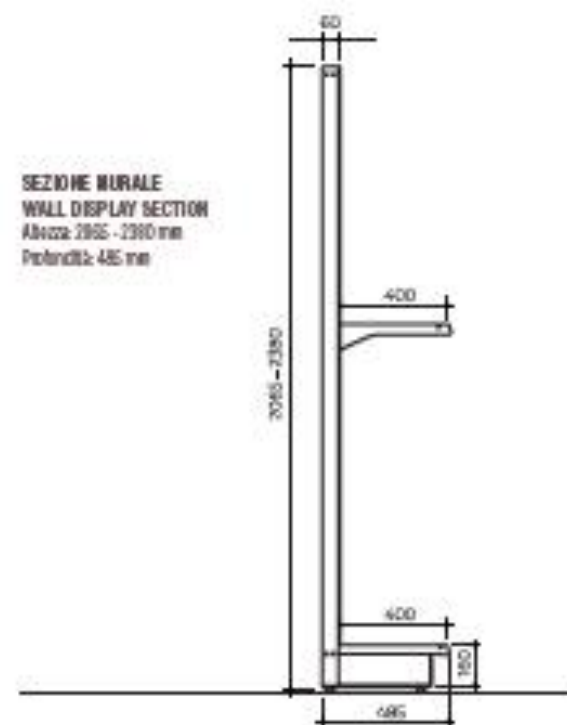

ESPOSITORI PRODOTTI FOOD GONDOLA

LA VERNICIATURA SULLLE SUPERFICIE METALLICHE AVVIENE MEDIANTE TRATTAMENTO ELETTROSTATICO A BASE DI POLVERI POLIURETANICHE ED EPOSSIPOLIESTERE PRIVE DI METALLI PESANTI E TQIC AI SENSI DELLE NORMATIVE CE 1807/2007 (REACH) E SONO CERTIFICATE SMART.

ELECTROSTATIC PAINTING OF METAL SURFACES IS MADE BY POLYURETHANE AND EPOXY POLYESTER POWDER COATING, METAL FREE AND TQIC, ACCORDING TO THE DIRECTIVES CE 1807/2007 (REACH) AND CERTIFICATE SMART.

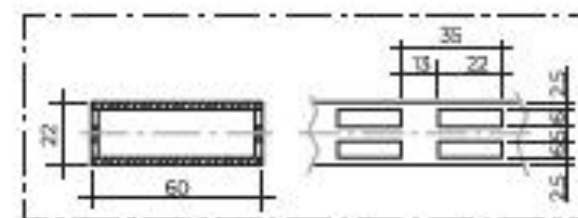

SEZIONE GONDOLA
WALL DISPLAY SECTION
Altezza: 1435 mm
Profondità: 378 mm

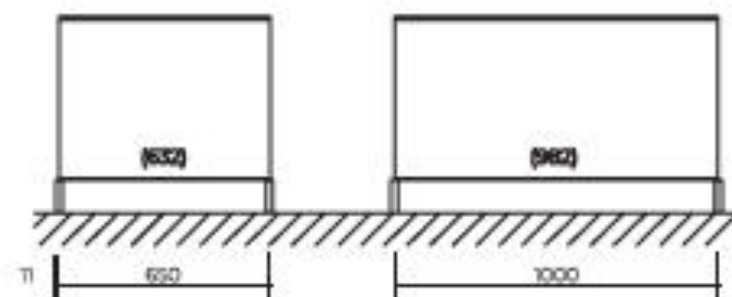
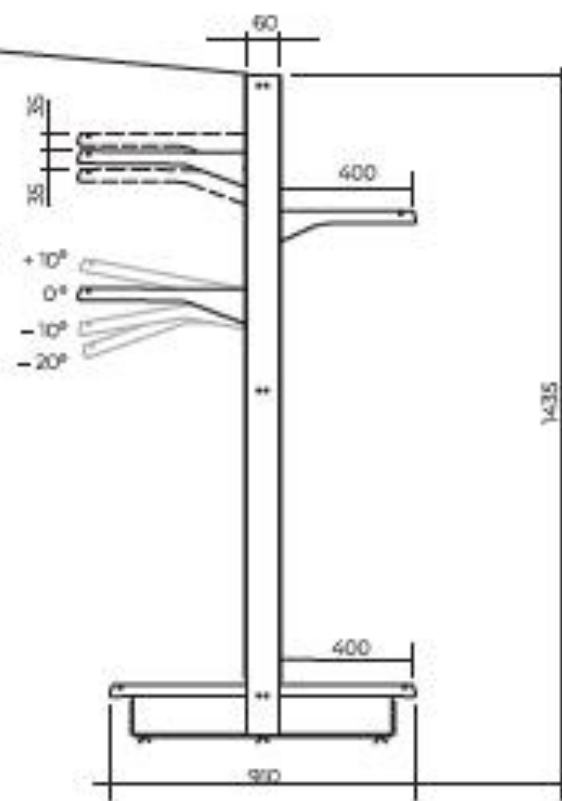

ESPOSITORI PRODOTTI FOOD SCAFFALE ORTOFRUTTA

PER MIGLIORARE L'ESPERIENZA SENSORIALE DEL CONSUMATORE, PUNTIAMO A VALORIZZARE LA FRESCHEZZA DEGLI ALIMENTI E AD OTTIMIZZARE GLI SPAZI: SOLUZIONI ESPOSITIVE IDEATE PER LA VENDITA DI FRUTTA E VERDURA FRESCA. TUTTI I NOSTRI COMPLEMENTI PER L'ORTOFRUTTA VENGONO COSTRUITI SECONDO LE NORMATIVE VIGENTI IN MATERIA DI SICUREZZA ALIMENTARE.

TO IMPROVE THE CONSUMER'S SENSORY EXPERIENCE, WE AIM TO ENHANCE FOOD FRESHNESS AND OPTIMIZE SPACE. YOU'LL FIND DISPLAY SOLUTIONS DESIGNED FOR THE SALE OF FRESH FRUITS AND VEGETABLES. ALL OUR FRUIT AND VEGETABLE COMPLMENTS ARE BUILT ACCORDING TO CURRENT FOOD SAFETY REGULATIONS.

ESPOSITORE AUTOPORTANTE ORTOFRUTTA (BANCARELLA) F&V FREE STANDING DISPLAY

UN ESPOSITORE ORTOFRUTTA MODULARE, CARATTERIZZATO DA UN DESIGN SEMPLICE MA FUNZIONALE CHE RICHIAMA GLI ESPOSITORI DELLE BOTTEGHE PIÙ TRADIZIONALI.

DIMENSIONI: L 1210 P 600 H 1600 mm
STRUTTURA IN TUBOLARE 30X30MM E RIPIANI STANDARD.

A FRUIT AND VEGETABLE MODULAR DISPLAY CHARACTERISED BY A SIMPLE BUT FUNCTIONAL DESIGN THAT IS SIMILAR TO THE DISPLAYS OF THE MOST TRADITIONAL SHOPS.
DIMENSION:
W 1210 D 600 H 1600 mm
DESCRIPTION: 30X30MM TUBULAR STRUCTURE AND STANDARD SHELVES.



MURALE ORTOFRUTTA CON 3 RIPIANI INCLINATI ZINCATI (OPPURE BONDOLA CON 4 RIPIANI)

F&V WALL DISPLAY WITH 3 GALVANIZED INCLINED SHELVES (OR BONDOLA WITH 4 INCL. SHELVES)

DIMENSIONI:
MURALE / WALL DISPLAY / MURAL:
L 1000 P 460 H 2065/2275 mm
BONDOLA: L 1000 P 920 H 1435 mm



RIPIANO INCLINATO FRUTTA VERDURA ZINCATO F&V GALVANIZED INCLINED SHELF L 1000 mm P 920 mm

SEZIONE MURALE WALL DISPLAY SECTION



REFRIGERATED WALL UNIT PENSILE REFRIGERATO

ELEMENTO ESSENZIALE PER OGNI ATTIVITÀ GASTRONOMICA. DOTATO DI COMPRESSORE INTEGRATO. ESSENTIAL ELEMENT FOR EVERY CULINARY ACTIVITIES. EQUIPPED WITH CONDENSING UNIT ON BOARD.

PUNTI DI FORZA

- gruppo compressore incorporato
- evaporazione automatica della condensa
- spalle in cristallo termico
- illuminazione superiore a LED
- piano internaccio regolabile

PRODUCT PLUS

- condensing unit on board
- automatic condensation evaporation
- thermal-glass side panels
- upper LED lighting
- adjustable shelf

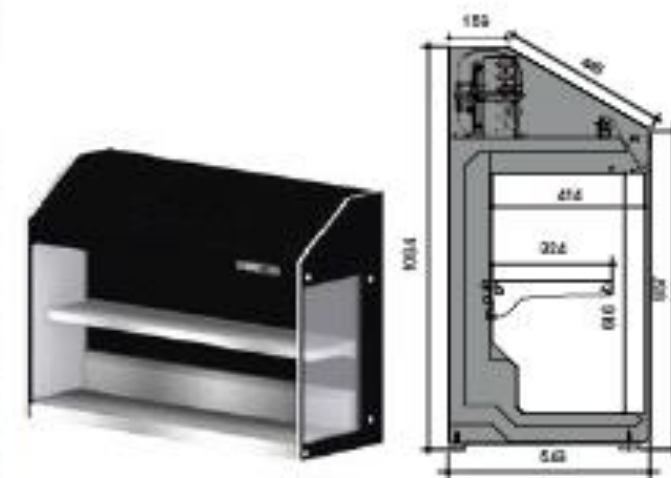

PENSILE REFRIGERATO - FREEZER CABINET

LENGTH	POWER CONSUMPTION	POWER SUPPLY	OPERATING TEMPERATURE
1100 mm	805 W	230 V 50 Hz	+4°C / +8°C
1500 mm	1005 W	230 V 50 Hz	+4°C / +8°C
2000 mm	1250 W	230 V 50 Hz	+4°C / +8°C

SCEGLI IL TUO STILE. MODELLI PENSATI PER COMPOSIZIONI FUNZIONALI, DIFFERENTI PER SPAZI E MATERIALI SCELTI.

CHOOSE YOUR STYLE. MODELS DESIGNED FOR FUNCTIONAL COMPOSITIONS, FOR DIFFERENT ATMOSPHERES AND MATERIALS CHOSEN.

LINEA
BASIC



Grigio

LINEA
EASY



S. Mercato

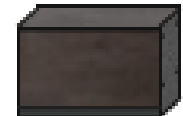

Rosato



Rosero



Vintage



Espresso



Verde Salita



Calceolaria Spazio



Torona



Spiccano

LINEA
LOOP



S. Mercato



Rosero

LINEA
DOMINO



S. Mercato



Rosero



Espresso



Calceolaria



Spiccano



Rosato



Vintage



Verde Salita



Torona

LINEA
DONEY



S. Mercato



Rosero

LINEA
FRAME



S. Mercato



Rosero



S. Mercato & Grigio

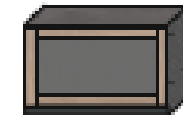

Rosero & Grigio



S. Mercato & Calceolaria



Rosero & Calceolaria



S. Mercato & Spiccano



Rosero & Spiccano



S. Mercato & Rosato



Rosero & Rosato



S. Mercato & Vintage



Rosero & Vintage



S. Mercato & Verde Salita



Rosero & Verde Salita



S. Mercato & Torona



Rosero & Torona

LINEA
HYVE



Grigio



S. Mercato & Calceolaria



Salita



Torona

SCEGLI IL TUO STILE. MODELLI PENSATI PER COMPOSIZIONI FUNZIONALI, DIFFERENTI PER SPAZI E MATERIALI SCELTI.

CHOOSE YOUR STYLE. MODELS DESIGNED FOR FUNCTIONAL COMPOSITIONS, FOR DIFFERENT ATMOSPHERES AND MATERIALS CHOSEN.

LINEA MIX



Giallo & Chiaro



Rosso & Chiaro

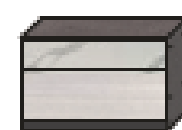

Chiaro & Chiaro



Quercia & Chiaro



Giallo & Rosso



Rosso & Spesso



Chiaro & Spesso



Quercia & Spesso



Giallo & Chiaro



Rosso & Chiaro



Chiaro & Chiaro



Quercia & Chiaro



Giallo & Spesso



Rosso & Verde Scuro



Chiaro & Verde Scuro



Quercia & Verde Scuro



Giallo & Bianco Lucido



Rosso & Bianco Lucido



Chiaro & Totono



Quercia & Totono

LINEA WOOD



Lino/Arno

LINEA WOOD ECO



Rosso



Quercia

LINEA REGIORGIO



Grafite



Bianco Opaco

LINEA CATHEDRAL



Grafite

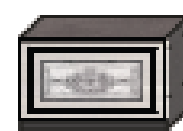

Chiaro

LINEA GINGER



Chiaro

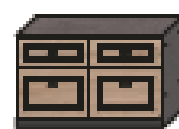

Rosso

LINEA POP



Verde Scuro & Bianco

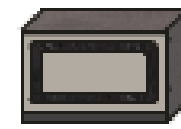

Totono & Spesso

LINEA VERT



Rosso Scuro



Rosso Oro Chiaro

LINEA LUXOR



Mosaico PNL

LINEA CROSS



Bianco Opaco + PNL



Chiaro + Chiaro

LINEA TUDOR

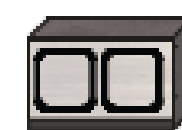

Chiaro

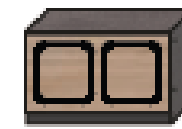

Rosso



Laccato/Opaco (Mosaico PNL)

LINEA PROVENCE

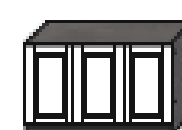

Laccato Bianco



Laccato/Opaco (Mosaico PNL)

LINEA SUBWAY TILE

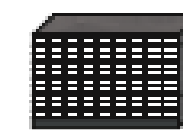

Laccato Bianco



Laccato Opaco (Mosaico PNL)

LINEA RIVA



Verde Scuro

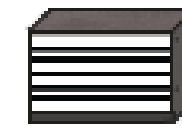

Verde Bianco Opaco

FINITURE TOP WORKTOP FINISHES

TOP LAMINATI | LAMINATED TOPS

SPESSORE 30 MM
PER TOP

THICKNESS 30MM
FOR WORKTOPS



TOP FENIX | FENIX TOPS



TOP STRATIFICATO HPL | STRATIFIED HPL

SPESSORE 30 MM
PER TOP

THICKNESS 30MM
FOR WORKTOPS



TOP GRES PORCELLANATO | PORCELAIN STONEWARE TOP



FINITURE PANNELLATURE PANELLING FINISHES

SPESORE 18 MM PER
BANCHI-SCHIENE 35 MM
PER PIANI-BOTTIGLIERE-
TAVOLI

THICKNESS 18 MM FOR
COUNTERS, RISER UNITS,
THICKNESS 35 MM FOR
SHELVES, BOTTLE RACKS,
TABLES

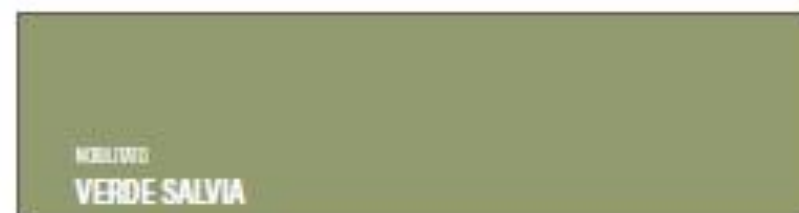

ALTRE PANNELLATURE
FRONTALI DI SPESSORE
VARIABILE (18-40 MM)

OTHER FRONT
CLADDINGS WITH
VARIABLE THICKNESS
(18-40 MM)



METALLI SPESSORE 3 MM | METALS THICK 3 MM



BANCHI NEUTRO H950MM AMBIENT COUNTERS H950

sezione section lato operatore operator side

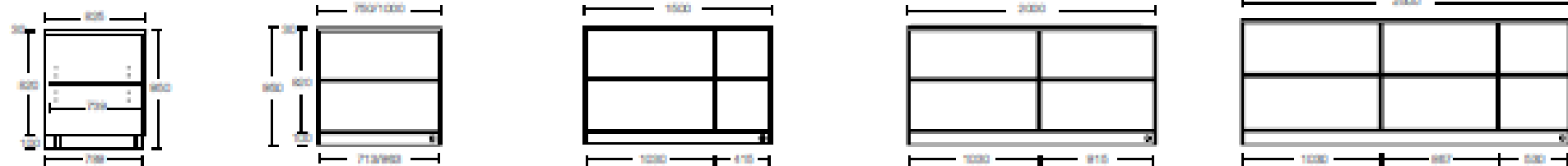

BANCO NEUTRO H950 P825MM AMBIENT COUNTER H950 P825MM
 BANCO BAR NEUTRO L750/1000 H950 P825MM AMBIENT BAR COUNTER W750/1000 H950 P825MM
 BANCO BAR NEUTRO L1500 H950 P825MM AMBIENT BAR COUNTER W1500 H950 P825MM
 BANCO BAR NEUTRO L2000 H950 P825MM AMBIENT BAR COUNTER W2000 H950 P825MM
 BANCO BAR NEUTRO L2500 H950 P825MM AMBIENT BAR COUNTER W2500 H950 P825MM

BANCHI BAR NEUTRO H1200MM AMBIENT BAR COUNTERS H1200

sezione section lato operatore operator side

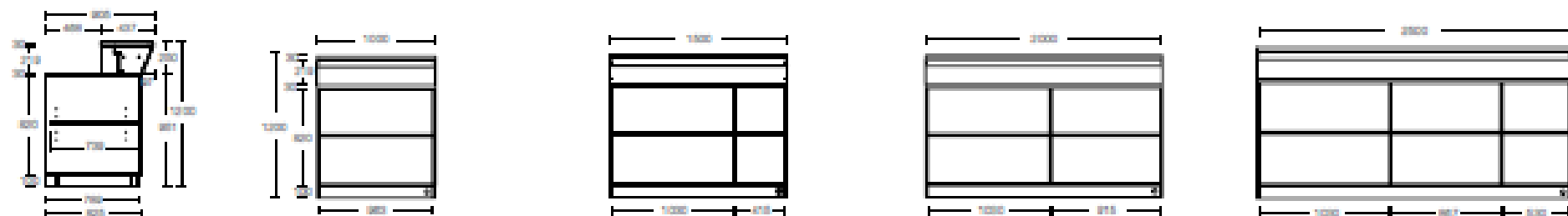

BANCO BAR NEUTRO H1200 P905MM AMBIENT BAR COUNTER H1200 P905MM
 BANCO BAR NEUTRO L1000 H1200 P905MM AMBIENT BAR COUNTER W1000 H1200 P905MM
 BANCO BAR NEUTRO L1500 H1200 P905MM AMBIENT BAR COUNTER W1500 H1200 P905MM
 BANCO BAR NEUTRO L2000 H1200 P905MM AMBIENT BAR COUNTER W2000 H1200 P905MM
 BANCO BAR NEUTRO L2500 H1200 P905MM AMBIENT BAR COUNTER W2500 H1200 P905MM

BANCHI NEUTRO CON VETRO ESPOSITORE AMBIENT COUNTERS WITH GLASS DISPLAYS

sezione section

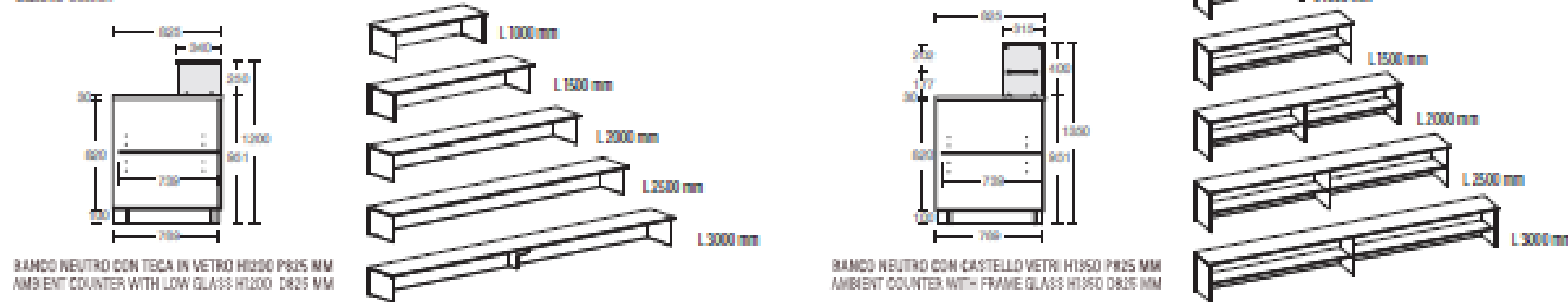

BANCO NEUTRO CON TECA IN VETRO H1200 P825 MM AMBIENT COUNTER WITH LOW GLASS H1200 D825 MM
 BANCO NEUTRO CON CASTELLO VETRI H1350 P825 MM AMBIENT COUNTER WITH FRAME GLASS H1350 D825 MM

BANCHI NEUTRO H950MM AMBIENT COUNTERS H950

BANCHI NEUTRO ANGOLARI ANGULAR AMBIENT COUNTERS

lato operatore operator side

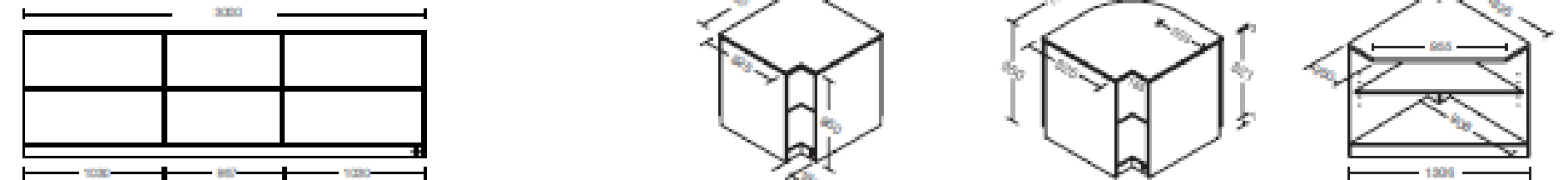

BANCO BAR NEUTRO L3000 H950 P825MM AMBIENT BAR COUNTER W3000 H950 P825MM
 ANGOLO ESTERNO 90° L1000 H950 P1000 MM EXTERNAL CORNER 90° W1000 H950 D1000 MM
 ANGOLO ESTERNO CURVO 90° L1010 H950 P1010 EXTERNAL CURVED CORNER 90° W1010 H950 D1010
 ANGOLO INTERNO 90° L825 H950 P825 MM INTERNAL CORNER 90° W825 H950 D825 MM

BANCHI BAR NEUTRO H1200MM AMBIENT BAR COUNTERS H1200

BANCHI NEUTRO ANGOLARI ANGULAR AMBIENT COUNTERS

lato operatore operator side

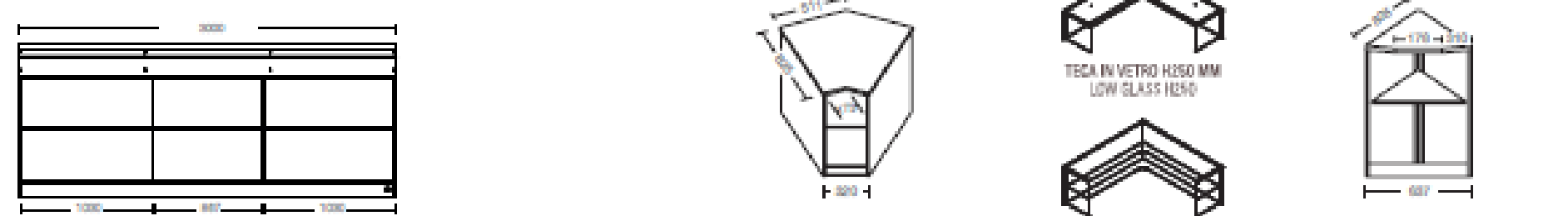

BANCO BAR NEUTRO L3000 H1200 P905MM AMBIENT BAR COUNTER W3000 H1200 P905MM
 ANGOLO ESTERNO 45° L945 H950 P825 MM EXTERNAL CORNER 45° W945 H950 D825 MM
 CASTELLO VETRI H250 MM FRAME GLASS H250
 ANGOLO INTERNO 45° L795 H950 P825 MM INTERNAL CORNER 45° W795 H950 D825 MM

BANCHI BAR NEUTRO ANGOLARI ANGULAR AMBIENT BAR COUNTERS

lato operatore operator side

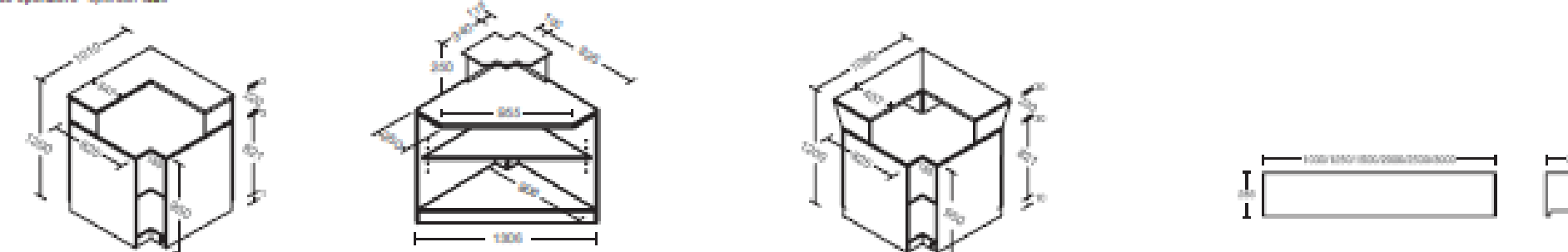

ANGOLO ESTERNO BAR 90° L1000 H1200 P1000 MM EXTERNAL BAR CORNER 90° W1000 H1200 D1000 MM
 ANGOLO INTERNO BAR 90° L825 H1200 P825 MM INTERNAL BAR CORNER 90° W825 H1200 D825 MM
 ANGOLO ESTERNO BAR 90° L1090 H1200 P1090 CON SOTTOBANCALINA IN METALLO EXTERNAL BAR CORNER 90° W1090 H1200 D1090 WITH STEEL UPPER TOP STRUCTURE
 BANCALINA IN HPL STRATIFICATO (BAULETTO) UPPER TOP STRUCTURE IN STRATIFIED HPL (BAULETTO)

BANCHI REFRIGERATI H950MM
REFRIGERATED COUNTERS H950

sezione section



BANCO CON CELLE REFRIGERATE STATICHE E MOTORE INCORPORATO H950 P825 MM
COUNTER WITH STATIC REFRIGERATED ROOMS & HERMETIC UNIT H950 D825 MM

BANCHI BAR REFRIGERATI H1200MM
REFRIGERATED BAR COUNTERS H1200 MM



BANCO BAR CON CELLE REFRIGERATE
STATICHE E MOTORE INCORPORATO
H1200 P825 MM
BAR COUNTER WITH STATIC
REFRIGERATED ROOMS & HERMETIC UNIT
H1200 D825 MM

VETRINA REFRIGERATE VENTILATE COMPACT H1200MM
VENTILATED REFRIGERATED COMPACT DISPLAY CASE H1200MM

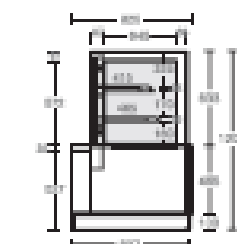

VETRINA REFR. VENTILADA
"COMPACT" CON MOTORE
INCORPORATO H1200 P825 MM
REFRIGERATED VENTILATED
"COMPACT" DISPLAY CASE WITH
HERMETIC UNIT H1200 D825 MM



VETRINA REFRIGERATE VENTILATE COMPACT H1350MM
VENTILATED REFRIGERATED COMPACT DISPLAY CASE H1350MM

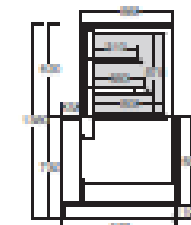

VETRINA REFR. VENTILADA
"COMPACT" CON MOTORE
INCORPORATO H1350 P825 MM
REFRIGERATED VENTILATED
"COMPACT" DISPLAY CASE WITH
HERMETIC UNIT H1350 D825 MM



VETRINE REFRIGERATE STATICHE H1350MM
STATIC REFRIGERATED DISPLAY CASES H1350 MM



VETRINA REFRIGERATA STATICA CON
MOTORE INCORPORATO H1350 D827 MM
STATIC REFRIGERATED DISPLAY CASES
WITH HERMETIC UNIT H1350 D827 MM

BANCHI DROP-IN REFRIGERATI VENTILATI
VENTILATED REFRIGERATED DROP-IN COUNTERS



BANCO DROP-IN REFRIGERATO VENTILATO
CON MOTORE INCORPORATO E TECA IN VETRO
H1200 P825 MM
VENTILATED REFRIGERATED DROP-IN
COUNTERS WITH HERMETIC UNIT & LOW GLASS
H1200 D825 MM

VETRINE REFRIGERATE STATICHE H1200MM
STATIC REFRIGERATED DISPLAY CASES H1200



VETRINA REFRIGERATA STATICA CON
MOTORE INCORPORATO H1200 P827 MM
STATIC REFRIGERATED DISPLAY CASES
WITH HERMETIC UNIT H1200 D827 MM

VETRINE REFRIGERATE VENTILATE H1350MM
VENTILATED REFRIGERATED DISPLAY CASES H1350 MM



VETRINA REFRIGERATA VENTILADA CON
MOTORE INCORPORATO H1350 P827 MM
REFRIGERATED VENTILATED DISPLAY CASE
WITH HERMETIC UNIT H1350 D827 MM

VETRINE RISCALDATE H1200MM HEATED DISPLAY CASES H1200 MM

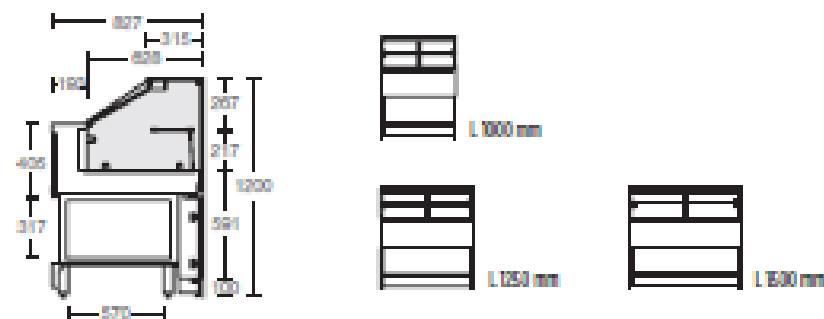

VETRINA CALDO SECCO H1200 P1827 MM
HOT DRY DISPLAY CASE H1200 D827 MM

VETRINE RISCALDATE H1350MM HEATED DISPLAY CASES H1350 MM

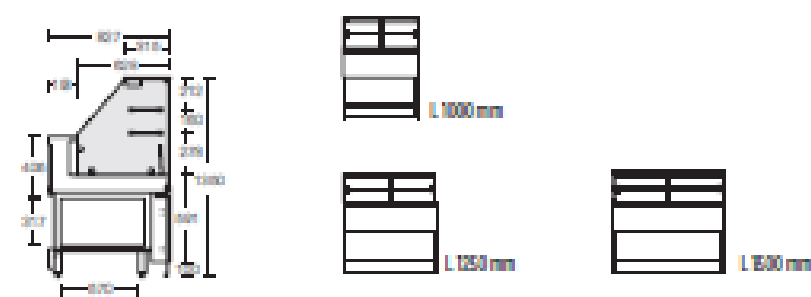

VETRINA CALDO SECCO H1350 P1827 MM
HOT DRY DISPLAY CASE H1350 D827 MM

VETRINE GELATERIA H1200MM GELATO DISPLAY CASES H1200 MM

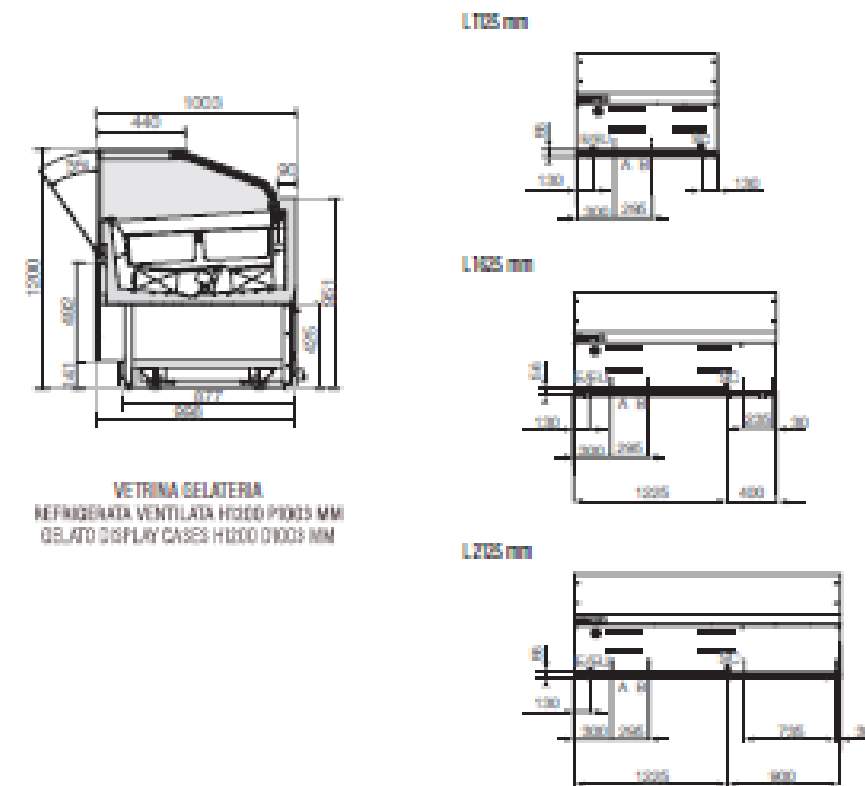

VETRINA GELATERIA
REFRIGERATA VENTILATA H1200 P1003 MM
GELATO DISPLAY CASES H1200 D1003 MM

VETRINE GELATERIA H1350MM GELATO DISPLAY CASES H1350 MM

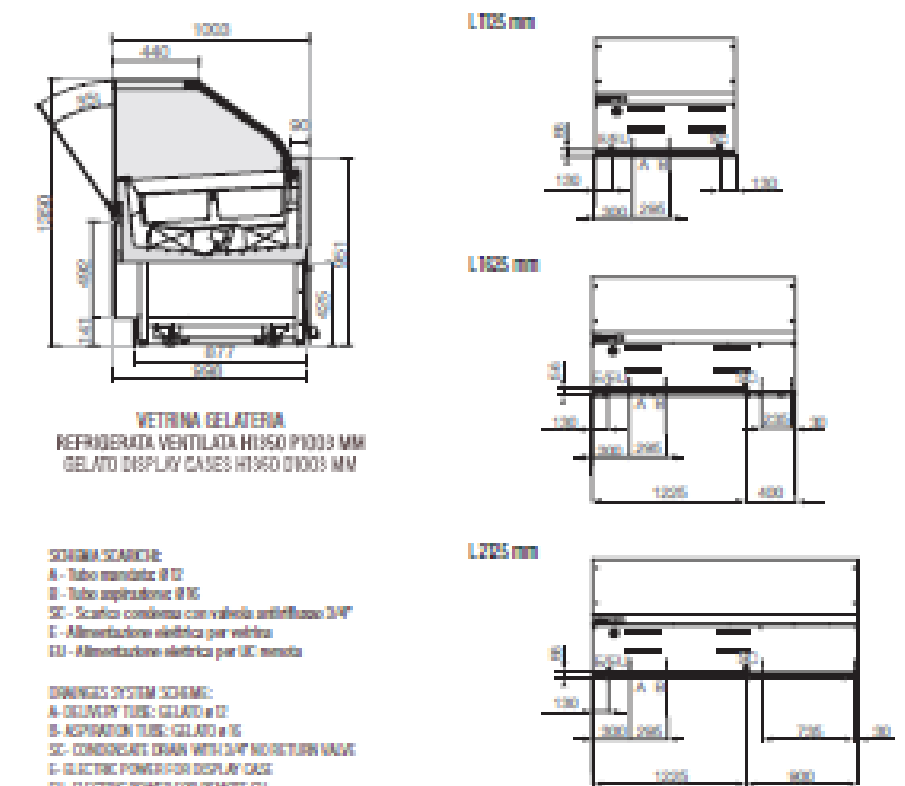

VETRINA GELATERIA
REFRIGERATA VENTILATA H1350 P1003 MM
GELATO DISPLAY CASES H1350 D1003 MM

SCHEMA SCHEMI:
A - Tubo mandata Ø 12
B - Tubo aspirazione Ø 16
SC - Scatola condensa con valvola antiriflusso 3/4"
E - Alimentazione elettrica per vetrine
EU - Alimentazione elettrica per remote EU

DRAINAGE SYSTEM SCHEME:
A - DELIVERY TUBE- GELATO Ø 12
B - ASPIRATION TUBE- GELATO Ø 16
SC - CONDENSATE DRAIN WITH DRY RETURN VALVE
E - ELECTRIC POWER FOR DISPLAY CASE
EU - ELECTRIC POWER FOR REMOTE EU

**VETRINE PANETTERIA NEUTRE H1200MM
BAKERY AMBIENT DISPLAY CASES H1200 MM**

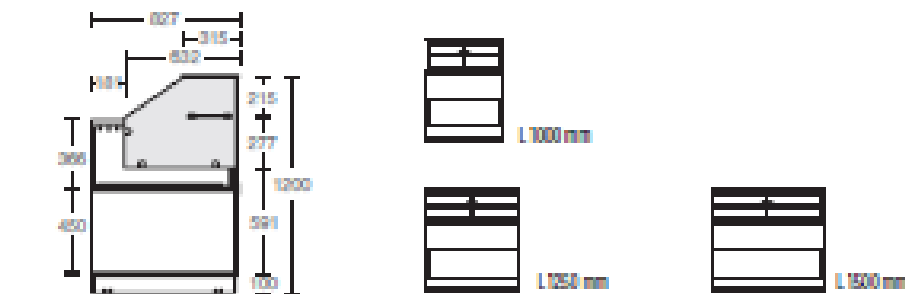

VETRINA PANETTERIA
NEUTRO H1200 P1825 MM
BAKERY AMBIENT DISPLAY CASE H1200
D827 MM

**VETRINE PANETTERIA NEUTRE H1350MM
BAKERY AMBIENT DISPLAY CASES H1350 MM**

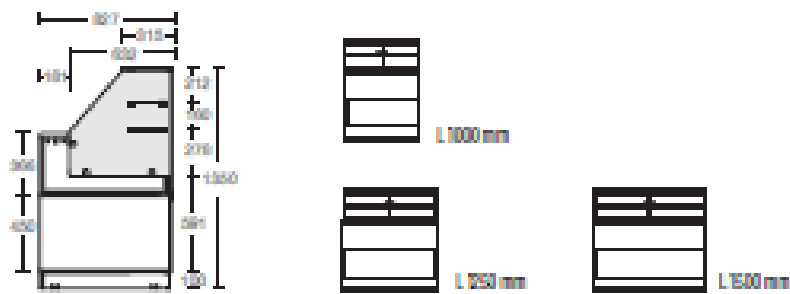

VETRINA PANETTERIA
NEUTRO H1350 P1825 MM
BAKERY AMBIENT DISPLAY CASE H1350
D827 MM

BASI RETRO REFRIGERATE REFRIGERATED BACK-BASES

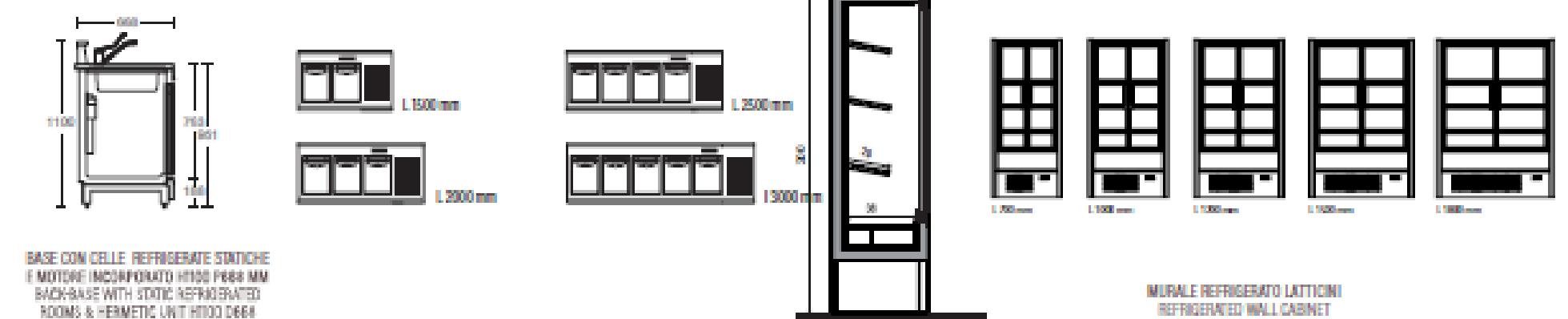

BASE CON CELLE REFRIGERATE SINTICHE
E MOTORE INCORPORATO H1100 P688 MM
BACK-BASE WITH SINTIC REFRIGERATED
ROOMS & HERMETIC UNIT H1100 D688

MURALE REFRIGERATO LATTICINI
REFRIGERATED WALL CABINET

RETROBANCO BACKCOUNTER

sezioni section

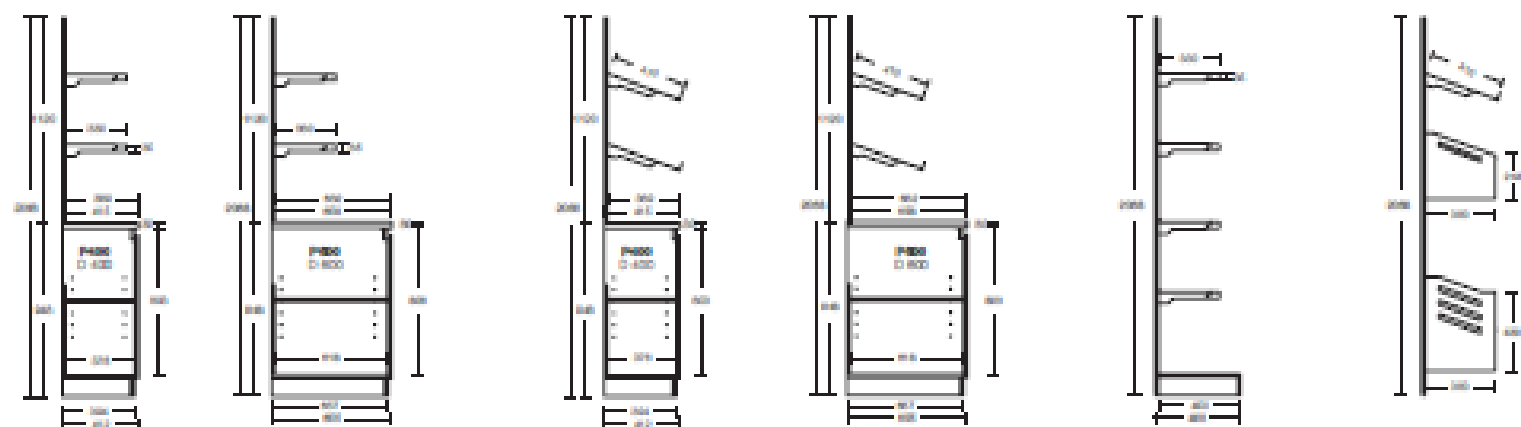

ALZATA BASE RETRO CON PIANI Dritti
WALL-MOUNTED UNIT AND BAR-BACK BASE UNIT WITH STRAIGHT SHELVES

ALZATA BASE RETRO CON PIANI PORTACESTI INCLINATI
WALL-MOUNTED UNIT AND BAR-BACK BASE UNIT WITH TILTED SHELVES

RETRO ESPOSITORE
BACK DISPLAYER UNIT

RETRO PANETTERIA
BACK BAKERY UNIT

SCAFFALI SHELVING UNIT

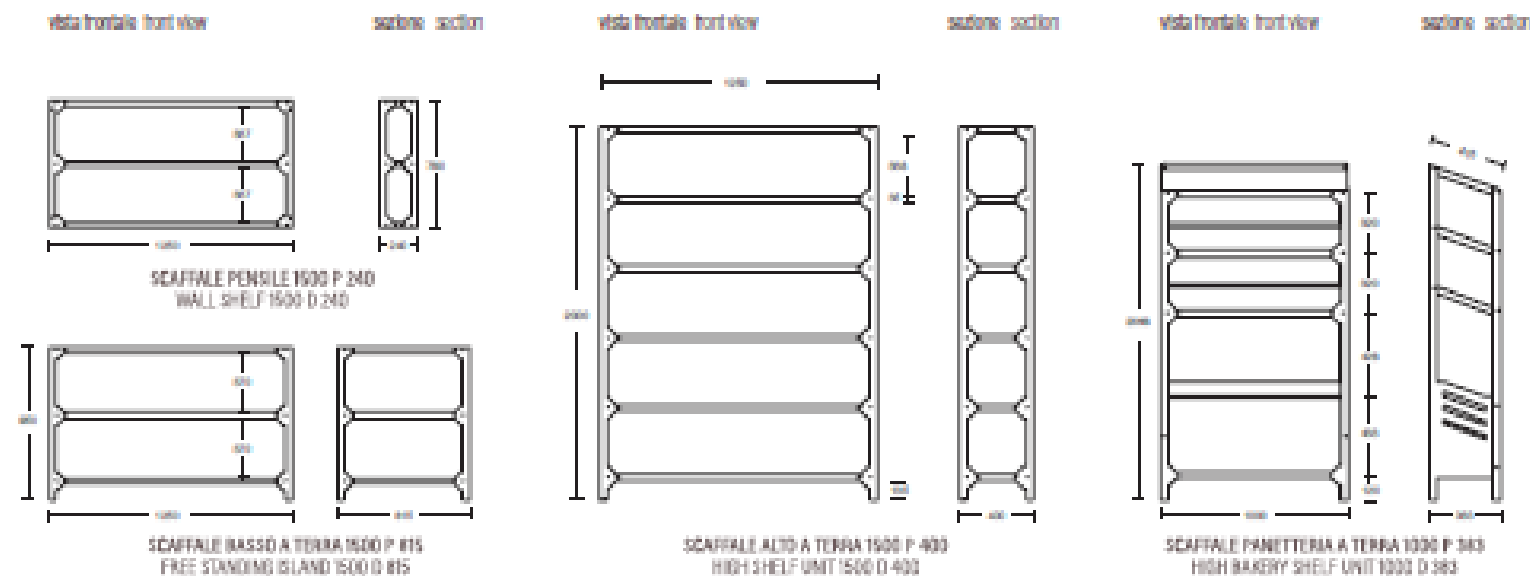

SCAFFALE PENDILE 1500 P 240
WALL SHELF 1500 D 240

SCAFFALE BASSO A TERRA 1500 P 415
FREE STANDING ISLAND 1500 D 415

SCAFFALE ALTO A TERRA 1500 P 400
HIGH SHELF UNIT 1500 D 400

SCAFFALE PANETTERIA A TERRA 1000 P 343
HIGH BAKERY SHELF UNIT 1000 D 343

BASE MACCHINA CAFFÈ COFFEE MACHINE BACKCOUNTER

vista frontale front view

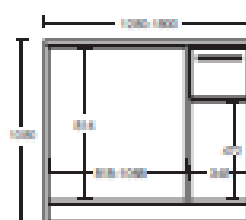

BASE PER MACCHINA CAFFÈ
COFFEE MACHINE UNIT

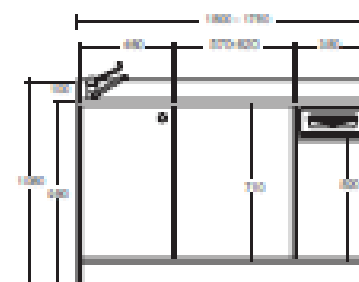

MODULO MACCHINA CAFFÈ RETRO COMBI CON 1 LAVABO
CAFFÈ MACHINE BACKCOUNTER COMBI WITH 1 SINK

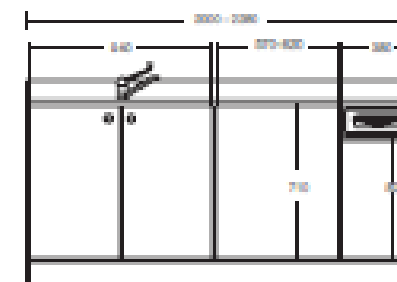

MODULO MACCHINA CAFFÈ RETRO COMBI CON 2 LAVELLI
CAFFÈ MACHINE BACKCOUNTER COMBI WITH 2 SINK

RETROALZATA BOTTIGLIERIA "CESAR" P 236
"CYCLOPE" BOTTLE COMPARTMENT D 236

BOTTIGLIERA WALL SHELF

vista frontale front view

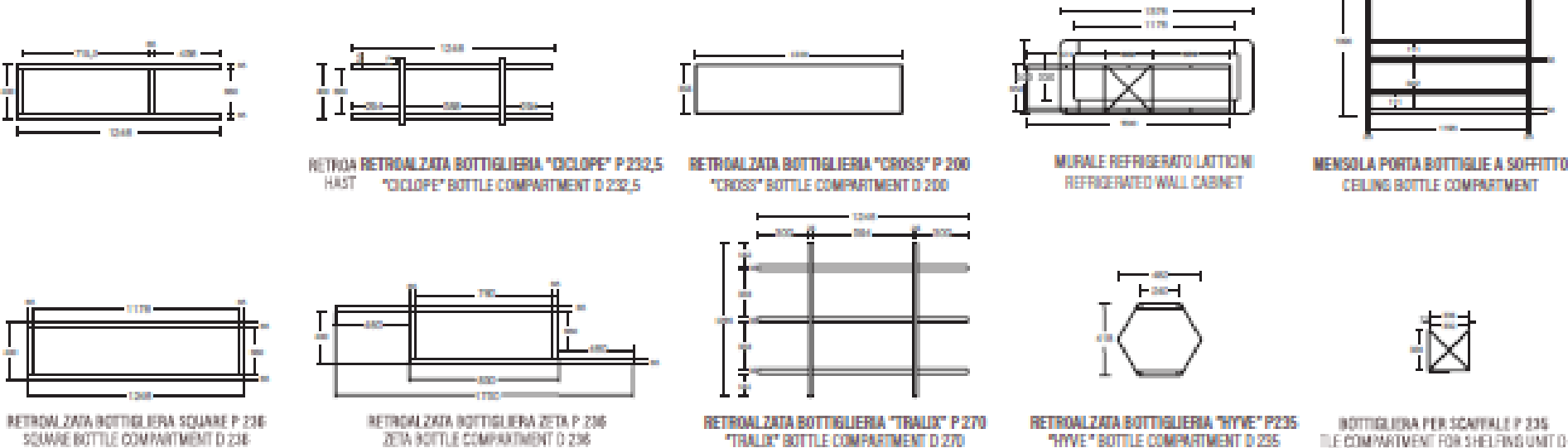

RETROA RETROALZATA BOTTIGLIERA "CYCLOPE" P 232,5
HAST "CYCLOPE" BOTTLE COMPARTMENT D 232,5

RETROALZATA BOTTIGLIERA "CROSS" P 200
"CROSS" BOTTLE COMPARTMENT D 200

MURALE REFRIGERATO LATTICINI
REFRIGERATED WALL CABINET

MENSOLA PORTA BOTTIGLIE A SOFFITTO
CEILING BOTTLE COMPARTMENT

RETROALZATA BOTTIGLIERA SQUARE P 236
SQUARE BOTTLE COMPARTMENT D 236

RETROALZATA BOTTIGLIERA ZETA P 236
ZETA BOTTLE COMPARTMENT D 236

RETROALZATA BOTTIGLIERA "TRALIX" P 270
"TRALIX" BOTTLE COMPARTMENT D 270

RETROALZATA BOTTIGLIERA "HYWE" P235
"HYWE" BOTTLE COMPARTMENT D 235

BOTTIGLIERA PER SCAFFALI P 235
TILE COMPARTMENT FOR SHELVING UNIT D 235



COLLEZIONE 2025



TURN-KEY s.r.l.

Via Comasina, 83 20161

MILANO (MI)

Cell. 380 4189220

Tel +39 02-56569030

P.IVA 08300600965

www.turn-key.it

e-mail: info@turn-key.it